

# Panasonic®

## Operating Instructions

---

### LCD Video Monitor

Model No. **BT-LH1760P**

Model No. **BT-LH1760E**

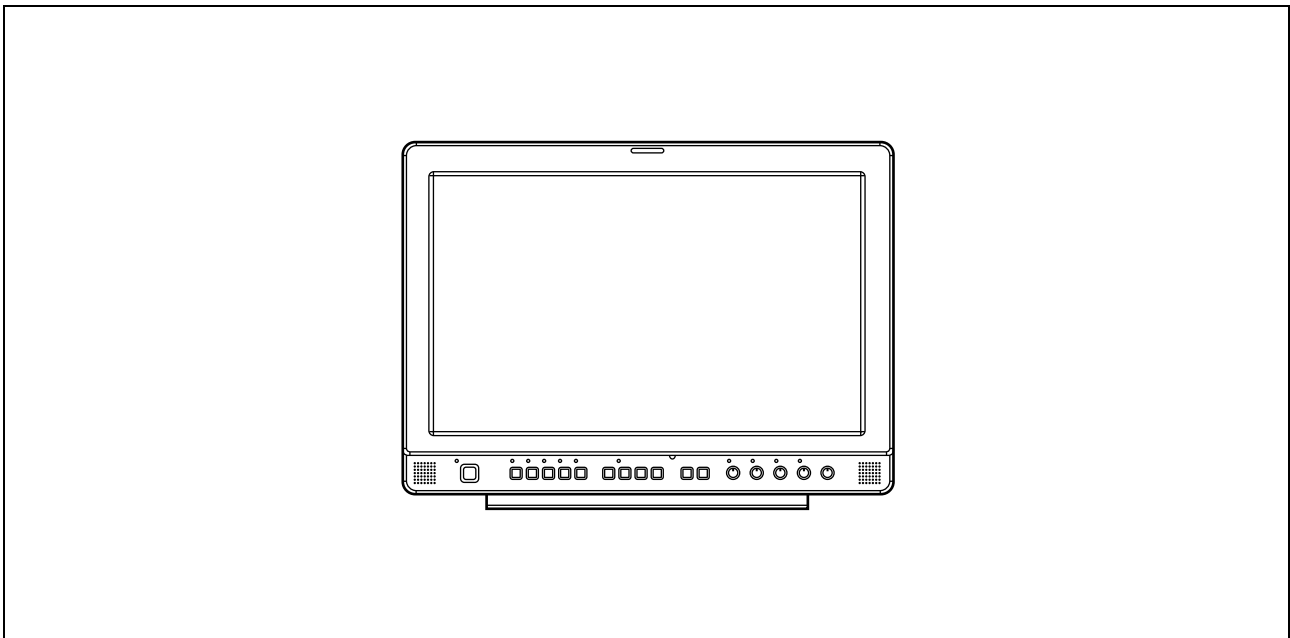

Before operating this product, please read the instructions carefully and save this manual for future use.

# Read this first ! (for BT-LH1760P)



CAUTION: TO REDUCE THE RISK OF ELECTRIC SHOCK, DO NOT REMOVE COVER (OR BACK). NO USER-SERVICEABLE PARTS INSIDE. REFER SERVICING TO QUALIFIED SERVICE PERSONNEL.



The lightning flash with arrowhead symbol, within an equilateral triangle, is intended to alert the user to the presence of uninsulated "dangerous voltage" within the product's enclosure that may be of sufficient magnitude to constitute a risk of electric shock to persons.



The exclamation point within an equilateral triangle is intended to alert the user to the presence of important operating and maintenance (servicing) instructions in the literature accompanying the appliance.

## ■ THIS EQUIPMENT MUST BE GROUNDED

To ensure safe operation, the three-pin plug must be inserted only into a standard three-pin power outlet which is effectively grounded through normal household wiring. Extension cords used with the equipment must have three cores and be correctly wired to provide connection to the ground. Wrongly wired extension cords are a major cause of fatalities. The fact that the equipment operates satisfactorily does not imply that the power outlet is grounded or that the installation is completely safe. For your safety, if you are in any doubt about the effective grounding of the power outlet, please consult a qualified electrician.

### CAUTION:

THE MAINS PLUG OF THE POWER SUPPLY CORD SHALL REMAIN READILY OPERABLE. THE AC RECEPTACLE (MAINS SOCKET OUTLET) SHALL BE INSTALLED NEAR THE EQUIPMENT AND SHALL BE EASILY ACCESSIBLE. TO COMPLETELY DISCONNECT THIS EQUIPMENT FROM THE AC MAINS, DISCONNECT THE POWER CORD PLUG FROM THE AC RECEPTACLE.

### WARNING:

- TO REDUCE THE RISK OF FIRE OR SHOCK HAZARD, DO NOT EXPOSE THIS EQUIPMENT TO RAIN OR MOISTURE.
- TO REDUCE THE RISK OF FIRE OR SHOCK HAZARD, KEEP THIS EQUIPMENT AWAY FROM ALL LIQUIDS. USE AND STORE ONLY IN LOCATIONS WHICH ARE NOT EXPOSED TO THE RISK OF DRIPPING OR SPLASHING LIQUIDS, AND DO NOT PLACE ANY LIQUID CONTAINERS ON TOP OF THE EQUIPMENT.

### CAUTION:

In order to maintain adequate ventilation, do not install or place this unit in a bookcase, built-in cabinet or any other confined space. To prevent risk of electric shock or fire hazard due to overheating, ensure that curtains and any other materials do not obstruct the ventilation.

### CAUTION:

TO REDUCE THE RISK OF FIRE OR SHOCK HAZARD AND ANNOYING INTERFERENCE, USE THE RECOMMENDED ACCESSORIES ONLY.

### CAUTION:

This apparatus can be operated at a voltage in the range of 100 - 240 V AC. Voltages other than 120 V are not intended for U.S.A. and Canada.

### CAUTION:

Operation at a voltage other than 120 V AC may require the use of a different AC plug. Please contact either a local or foreign Panasonic authorized service center for assistance in selecting an alternate AC plug.

### CAUTION:

- Keep the temperature inside the rack to between 41°F to 95°F (5°C to 35°C).
- Bolt the rack securely to the floor so that it will not topple over.

### CAUTION:

Excessive sound pressure from earphones and headphones can cause hearing loss.

### WARNING:

Installation should only be performed by qualified installation personnel. Improper installation may result in the entire apparatus falling down and causing injury.

### CAUTION:

Check the installation at least once a year. An improper installation could cause the monitor to fall off resulting in personal injury.

### CAUTION:

Remove the wall mount adaptor when not used. Otherwise people moving in the vicinity of the monitor could get caught on the bracket and be injured.

 indicates safety information.

### Notice (U.S.A. only):

This product has a fluorescent lamp that contains mercury. Disposal may be regulated in your community due to environmental considerations. For disposal or recycling information, please contact your local authorities, or the Electronic Industries Alliance: <http://www.eiae.org>.

# Read this first ! (for BT-LH1760P) (continued)

## FCC NOTICE (USA)

### Declaration of Conformity

Model Number: BT-LH1760P  
Trade Name: PANASONIC  
Responsible Party: Panasonic Corporation of North America  
One Panasonic Way, Secaucus, NJ07094  
Support contact: Panasonic Broadcast & Television Systems Company  
1-800-524-1448

This device complies with Part 15 of FCC Rules.

Operation is subject to the following two conditions:

(1) This device may not cause harmful interference, and (2) this device must accept any interference received, including interference that may cause undesired operation.

To assure continued compliance, follow the attached installation instructions and do not make any unauthorized modifications.

### Note:

This equipment has been tested and found to comply with the limits for a class B digital device, pursuant to Part 15 of the FCC Rules. These limits are designed to provide reasonable protection against harmful interference in a residential installation. This equipment generates, uses, and can radiate radio frequency energy, and if not installed and used in accordance with the instructions, may cause harmful interference to radio communications. However, there is no guarantee that interference will not occur in a particular installation. If this equipment does cause harmful interference to radio or television reception, which can be determined by turning the equipment off and on, the user is encouraged to try to correct the interference by one of the following measures:

- Reorient or relocate the receiving antenna.
- Increase the separation between the equipment and receiver.
- Connect the equipment into an outlet on a circuit different from that to which the receiver is connected.
- Consult the dealer or an experienced radio/TV technician for help.

The user may find the booklet "Something About Interference" available from FCC local regional offices helpful.

### Warning:

To assure continued FCC emission limit compliance, follow the attached installation instructions and the user must use only shielded interface cables when connecting to host computer or peripheral devices. Also, any unauthorized changes or modifications to this equipment could void the user's authority to operate this device.

## IMPORTANT SAFETY INSTRUCTIONS

- 1) Read these instructions.
- 2) Keep these instructions.
- 3) Heed all warnings.
- 4) Follow all instructions.
- 5) Do not use this apparatus near water.
- 6) Clean only with dry cloth.
- 7) Do not block any ventilation openings. Install in accordance with the manufacturer's instructions.
- 8) Do not install near any heat sources such as radiators, heat registers, stoves, or other apparatus (including amplifiers) that produce heat.
- 9) Do not defeat the safety purpose of the polarized or grounding-type plug. A polarized plug has two blades with one wider than the other. A grounding-type plug has two blades and a third grounding prong. The wide blade or the third prong are provided for your safety. If the provided plug does not fit into your outlet, consult an electrician for replacement of the obsolete outlet.
- 10) Protect the power cord from being walked on or pinched particularly at plugs, convenience receptacles, and the point where they exit from the apparatus.
- 11) Only use attachments/accessories specified by the manufacturer.
- 12) Use only with the cart, stand, tripod, bracket, or table specified by the manufacturer, or sold with the apparatus. When a cart is used, use caution when moving the cart/apparatus combination to avoid injury from tip-over.
- 13) Unplug this apparatus during lightning storms or when unused for long periods of time.
- 14) Refer all servicing to qualified service personnel. Servicing is required when the apparatus has been damaged in any way, such as power-supply cord or plug is damaged, liquid has been spilled or objects have fallen into the apparatus, the apparatus has been exposed to rain or moisture, does not operate normally, or has been dropped.



S3125A

# Read this first ! (for BT-LH1760E)

## ■ THIS EQUIPMENT MUST BE EARTHED

To ensure safe operation, the three-pin plug must be inserted only into a standard three-pin power point which is effectively earthed through normal house-hold wiring.

Extension cords used with the equipment must have three cores and be correctly wired to provide connection to the earth. Wrongly wired extension cords are a major cause of fatalities. The fact that the equipment operates satisfactorily does not imply that the power point is earthed or that the installation is completely safe. For your safety, if you are in any doubt about the effective earthing of the power point, please consult a qualified electrician.

## ■ DO NOT REMOVE PANEL COVERS BY UNSCREWING THEM.

To reduce the risk of electric shock, do not remove covers. No user serviceable parts inside.

Refer servicing to qualified service personnel.

### CAUTION:

THE MAINS PLUG OF THE POWER SUPPLY CORD SHALL REMAIN READILY OPERABLE. THE AC RECEPTACLE (MAINS SOCKET OUTLET) SHALL BE INSTALLED NEAR THE EQUIPMENT AND SHALL BE EASILY ACCESSIBLE. TO COMPLETELY DISCONNECT THIS EQUIPMENT FROM THE AC MAINS, DISCONNECT THE POWER CORD PLUG FROM THE AC RECEPTACLE.

### WARNING:

- TO REDUCE THE RISK OF FIRE OR SHOCK HAZARD, DO NOT EXPOSE THIS EQUIPMENT TO RAIN OR MOISTURE.
- TO REDUCE THE RISK OF FIRE OR SHOCK HAZARD, KEEP THIS EQUIPMENT AWAY FROM ALL LIQUIDS. USE AND STORE ONLY IN LOCATIONS WHICH ARE NOT EXPOSED TO THE RISK OF DRIPPING OR SPLASHING LIQUIDS, AND DO NOT PLACE ANY LIQUID CONTAINERS ON TOP OF THE EQUIPMENT.

### CAUTION:

TO REDUCE THE RISK OF FIRE OR SHOCK HAZARD AND ANNOYING INTERFERENCE, USE THE RECOMMENDED ACCESSORIES ONLY.

### CAUTION:

In order to maintain adequate ventilation, do not install or place this unit in a bookcase, built-in cabinet or any other confined space. To prevent risk of electric shock or fire hazard due to overheating, ensure that curtains and any other materials do not obstruct the ventilation.

### CAUTION:

- Keep the temperature inside the rack to between 5°C to 35°C.
- Bolt the rack securely to the floor so that it will not topple over.

### CAUTION:

Excessive sound pressure from earphones and headphones can cause hearing loss.

### WARNING:

Installation should only be performed by qualified installation personnel. Improper installation may result in the entire apparatus falling down and causing injury.

### CAUTION:

Check the installation at least once a year. An improper installation could cause the monitor to fall off resulting in personal injury.

### CAUTION:

Remove the wall mount adaptor when not used. Otherwise people moving in the vicinity of the monitor could get caught on the bracket and be injured

 indicates safety information.

## Read this first ! (for BT-LH1760E) (continued)

### Operating precaution

Operation near any appliance which generates strong magnetic fields may give rise to noise in the video and audio signals. If this should be the case, deal with the situation by, for instance, moving the source of the magnetic fields away from the unit before operation.

## Caution for AC Mains Lead

### FOR YOUR SAFETY PLEASE READ THE FOLLOWING TEXT CAREFULLY.

This product is equipped with 2 types of AC mains cable. One is for continental Europe, etc. and the other one is only for U.K.

Appropriate mains cable must be used in each local area, since the other type of mains cable is not suitable.

#### FOR CONTINENTAL EUROPE, ETC.

Not to be used in the U.K.

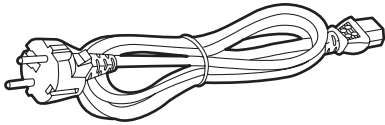

#### FOR U.K. ONLY

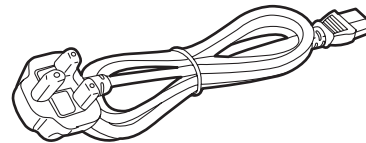

#### FOR U.K. ONLY

This appliance is supplied with a moulded three pin mains plug for your safety and convenience.

A 13 amp fuse is fitted in this plug.

Should the fuse need to be replaced please ensure that the replacement fuse has a rating of 13 amps and that it is approved by ASTA or BSI to BS1362.

Check for the ASTA mark  or the BSI mark  on the body of the fuse.

If the plug contains a removable fuse cover you must ensure that it is refitted when the fuse is replaced.

If you lose the fuse cover the plug must not be used until a replacement cover is obtained.

A replacement fuse cover can be purchased from your local Panasonic Dealer.

#### How to replace the fuse

1. Open the fuse compartment with a screwdriver.

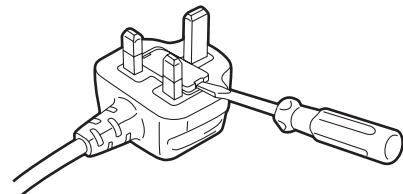

2. Replace the fuse.

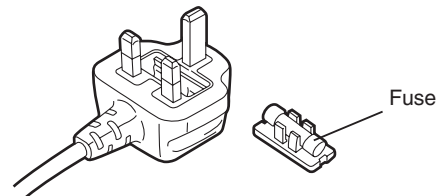

 indicates safety information.

## Transportation precautions

Do not try to lift the monitor by grabbing the panel.

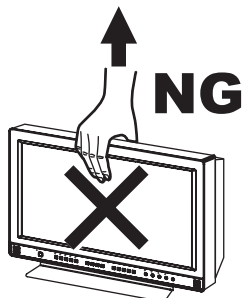

Do not place the monitor face down during transportation to prevent damaging it. Keep it upright.



Do not expose the LCD panel to strong pressure or pressure from pointed objects. Take care especially during transportation.

Exposing the LCD panel to strong pressure may result in blurring or other damage.

# Precautions for Use

---

- The LCD screen is manufactured to precise specifications. Although over 99.99% of the pixels function normally, 0.01% of the pixels are either missing or constantly lit (red, blue or green). This is normal and not a cause for concern.
- The liquid crystal protection panel is a specially manufactured component. Wiping it with a hard cloth, or rubbing it vigorously will scratch the surface.
- If a still image is displayed for an extended period of time, it may generate a temporary afterimage (phosphor burn-in). (However, such images can be removed by displaying normal video for a while.)
- The response speed and brightness of liquid crystal vary with ambient temperatures.
- Let authorized service person handle installation.  
Be sure to consult with the service person about the installation. Make sure that the wall is strong enough to endure the weight of this unit including the mount fittings. If not strong enough, it may fall off resulting in injury.
- Do not install the unit in a place exposed to direct sunlight, as it may damage the cabinet and the LCD screen.
- Be sure to attach a protection panel (optional accessory) when the unit is used outdoors.
- Do not install the unit in locations where enough space cannot be provided around it as heat may build up inside preventing normal operation. Be sure to provide enough space around the unit.
- Exposing the LCD screen to intense light sources will impair its characteristics and lower image quality.
- In an environment exposed to drastic temperature fluctuations, condensation may build up on and inside the LCD screen. This may lower the quality of the screen and may damage it.
- Some video images may appear blurred on the screen.
- Leaving the unit in a location exposed to high temperature and humidity for an extended period of time may damage the LCD screen and cause blurring.

## Contents

---

<b>Read this first !</b> .....	2	Marker types.....	19
<b>Transportation precautions</b> .....	5	VIDEO CONFIG .....	20
<b>Precautions for Use</b> .....	6	SYSTEM CONFIG.....	22
<b>Standard accessories</b> .....	6	FUNCTION.....	23
<b>Optional units</b> .....	6	GPI .....	29
<b>Outline</b> .....	7	INPUT SELECT.....	30
<b>Dimensions</b> .....	7	AUDIO .....	32
<b>Controls and Their Functions</b> .....	8	DISPLAY SETUP .....	33
Video monitor unit .....	8	CONTROL.....	34
Front panel .....	9	HOURMETER .....	34
Rear panel.....	10	<b>REMOTE Specifications</b> .....	36
<b>Power Supply</b> .....	11	<b>How to Attach the Rack Mount</b> .....	40
<b>How to Use the On Screen Menu</b> .....	12	<b>Maintenance Inspections</b> .....	40
<b>User Data</b> .....	16	<b>Error and Warning Displays</b> .....	41
<b>Main Menu</b> .....	17	<b>Maintenance</b> .....	41
Menu configuration.....	17	<b>Specifications</b> .....	42
MARKER.....	18		

## Standard accessories

---

<For BT-LH1760P>

- Operating instructions x 1
- Warranty (Card) x 1
- Power cord x 1
- Power cord hook x 1
- Screw x 1

<For BT-LH1760E>

- Operating instructions x 1
- AC mains lead x 2
- AC mains lead hook x 1
- Screw x 1

## Optional units

---

**Rack Mount Adaptor** BT-MA1710G (Installation instructions → page 40)

**Wall Mount Adaptor** BT-WMA17G (Leave installation of the wall mount adaptor to authorized personnel.)

**Protection Panel** BT-PRP17G (Refer to the installation instructions in the operating instructions supplied with the protection panel.)

# Outline

The BT-LH1760 LCD monitor was designed especially for broadcasting service and business use. It is equipped with a high performance 17.0-inch wide LCD display panel.

## ■ High performance LCD panel

This monitor achieves outstanding color reproduction, a wide viewing angle, and high-speed response. The double-speed drive in the BT-LH1760 has substantially reduced image lag.

## ■ Immediate image output of input signals

The time-lag caused by IP field unit conversion<sup>\*1</sup> has been eliminated, and the delay from input until image output has been suppressed to the absolute minimum.

\*1 Conversion from interlace to progressive scanning.

## ■ Multi-format image compatibility

- This monitor is equipped with SDI (HD/SD compatible), VIDEO, YPbPr/RGB, DVI-D (HDCP compatible) input jacks.
- It supports both NTSC and PAL TV broadcast systems.

## ■ A host of functions

- Split-screen function  
You can divide the screen into two windows, and compare the windows for critical color matching using the same input terminal and same format.
- Pixel-to-pixel mode  
During HD signal input, use this feature to see video in its native resolution (that is every pixel of the original corresponds to one pixel on the screen).
- Time code display  
During HD SDI input, you can select to display VITC, LTC or UB time code.
- Closed caption  
During VIDEO (NTSC) input, this feature displays the closed caption information embedded in the video signal. (EIA-608 compliant)
- Waveform and vector display  
This feature shows the waveform (for SDI, VIDEO and YPbPr inputs) and vector display (for SDI input) of input signals.
- Cross hatch overlay function  
Displays markers at regular vertical and horizontal intervals to facilitate composition.

## ■ REMOTE control

Depending on the intended use of the monitor, you can select between parallel remote control (GPI) and serial remote control (RS232C).

# Dimensions

Unit: mm (inches)

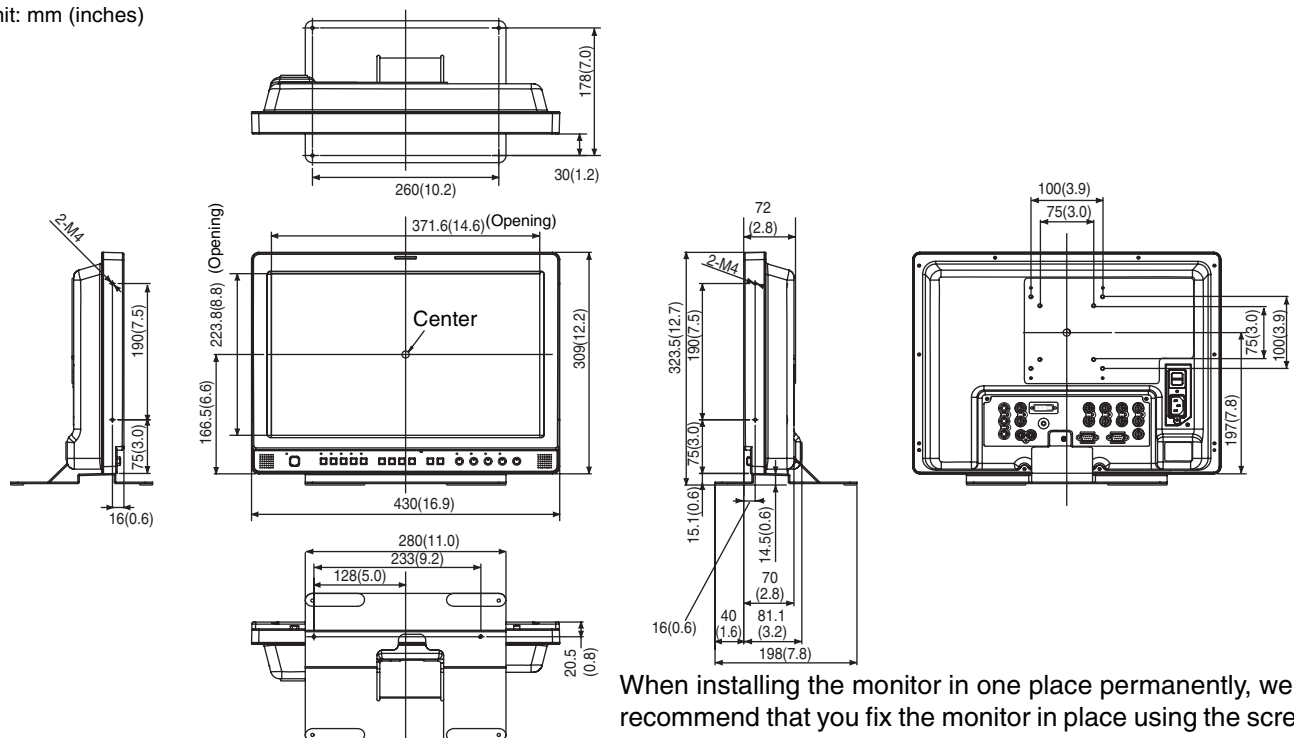

When installing the monitor in one place permanently, we recommend that you fix the monitor in place using the screw holes in the lower part of the stand.

# Controls and Their Functions

## Video monitor unit

### Front view

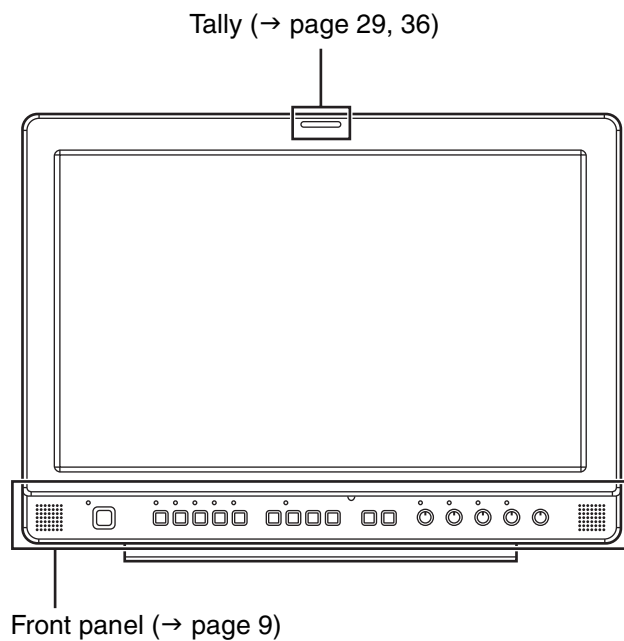

### Rear view

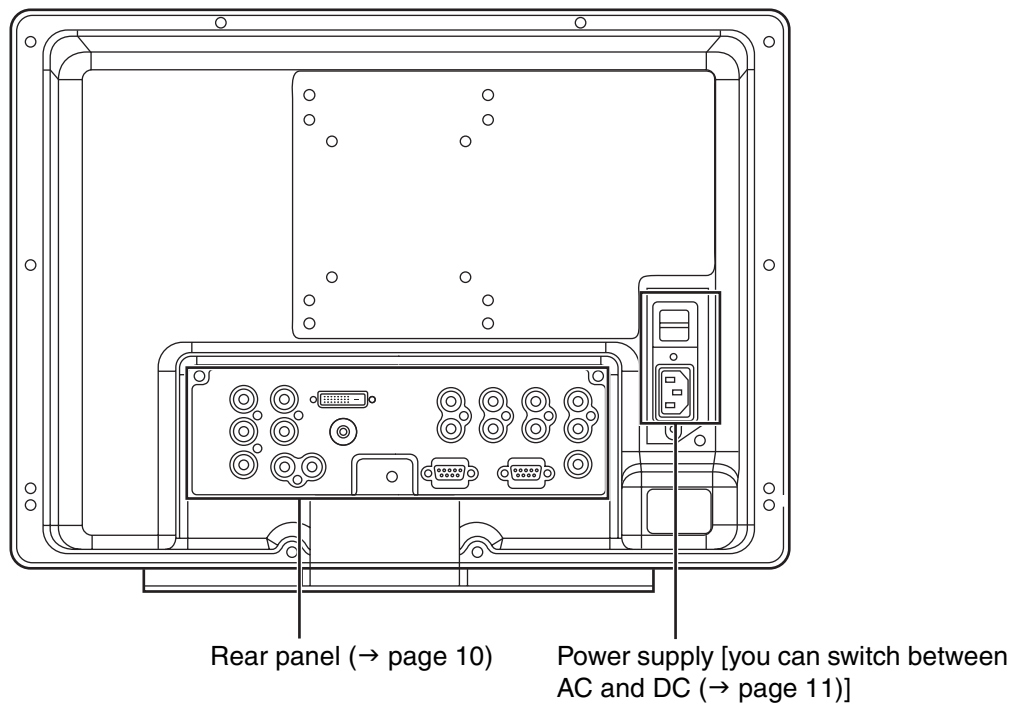



# Controls and Their Functions (continued)

## Front panel

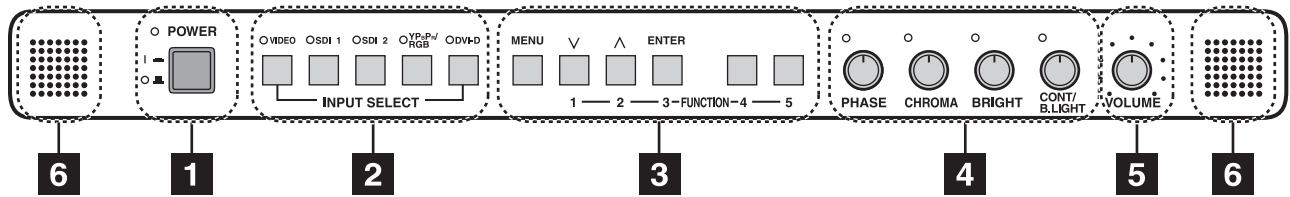

### 1 POWER switch

Switches the power supply ON/OFF. When the power is ON, the LED (green) lights up.

### 2 INPUT SELECT buttons

Selects the signal input line. The green LED light above the button indicates the selected input signal.

VIDEO : Video input

SDI1 : Serial digital interface input (HD/SD compatible)

SDI2 : Serial digital interface input (HD/SD compatible)

YP<sub>B</sub>P<sub>R</sub>/RGB : Analog component (YP<sub>B</sub>P<sub>R</sub>) or RGB input. Also compatible with PC input RGB.

\* When using PC Input, select "RGB-COMP" from "YP<sub>B</sub>P<sub>R</sub>/RGB" in the "INPUT SELECT" menu (→ page 30).

DVI-D : DVI-D input (HDCP compatible)

\* When using PC Input, select "DVI-COMP" from "DVI-D" in the "INPUT SELECT" menu (→ page 30).

### 3 MENU, FUNCTION buttons

Use these buttons to display menus, select and adjust settings and confirm menu selections.

MENU : Press to open a menu, exit a menu or return to a previous menu.

∇/FUNCTION1 : Moves the cursor downwards and selects items.  
It also confirms a menu item assigned to FUNCTION1.

∧/FUNCTION2 : Moves the cursor upwards and selects items.  
It also confirms a menu item assigned to FUNCTION2.

ENTER/FUNCTION3 : Press to confirm a setting or to open a submenu.  
It also confirms a menu item assigned to FUNCTION3.

FUNCTION4 : Confirms a menu item assigned to FUNCTION4.

FUNCTION5 : Confirms a menu item assigned to FUNCTION5.

\* When the control lock is on, the key mark appears and FUNCTION does not operate.

### 4 Picture adjusting knob

PHASE 0 - 60 (30)

CHROMA 0 - 60 (30)

BRIGHT 0 - 60 (30)

CONT [CONTRAST] 0 - 60 (50) / B.LIGHT [BACKLIGHT] 0 - 60 (60)

( ) denotes factory preset values.

Turn or press this knob to display and adjust menu settings. Press the knob a second time to save settings.

When values are changed from the factory defaults, the LED above the knob (amber) lights.

Settings are loaded when the monitor is turned on. The settings are saved when the knob is pressed, or when 10 seconds have elapsed after they have been changed. However, operating changes cannot be made in the following conditions.

\* When the control lock is on, the key mark appears and setting values cannot be changed (→ page 34).

\* When the MONO function is ON (→ page 20), [PHASE] and [CHROMA] operations are disabled.

\* When using "RGB-COMP" input or "DVI-COMP" input, [PHASE] and [CHROMA] operations are disabled.

\* While operating HV DELAY (→ page 24) (when set to any other setting than OFF), [BRIGHT] operation is disabled.

### 5 Volume knob

Turn this knob to adjust speaker and headphones volume.

### 6 Speaker

The speaker reproduces audio input from the AUDIO input terminal or SDI terminal (embedded audio).

\* Connecting headphones to the HEADPHONES output connector turns off the speakers.

# Controls and Their Functions (continued)

## Rear panel

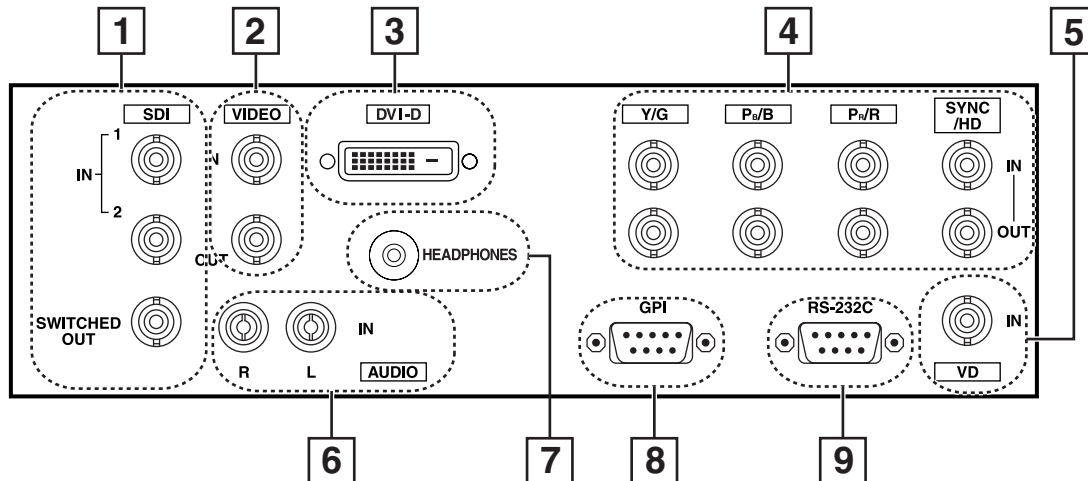

### 1 SDI (HD/SD) terminal (BNC)

IN1 : This is the SDI input terminal (compatible with HD/SD automatic switching).  
IN2 : This is the SDI input terminal (compatible with HD/SD automatic switching).  
SWITCHED OUT : This is the active through-out terminal for the SDI input signal being displayed on the screen.  
\* SDI active through-out is only output when [SDI1] or [SDI2] is selected using the [INPUT SELECT] buttons. It is not output when anything other than SDI is selected. This terminal supports embedded audio. When multiple monitors are connected in a daisy chain\* pattern using the SDI active through-out, flicker or noise may occur on the screen, depending on the quality of the original signal, length of cables or the number of monitors connected.

#### \* Daisy chain connection:

This is a connection method for distributing a signal to two or more devices by connecting the through-out terminal of the first device to an input terminal of the second device, the through-output terminal of the second device to an input terminal of the third device, and so on.

### 2 VIDEO terminal (BNC)<sup>\*1\*2</sup>

IN : This is the VIDEO signal (composite signal) input terminal.  
OUT : This is the input signal through-out terminal.

### 3 DVI-D terminal (DVI-D)

An HDCP compliant DVI-D signal input terminal.

### 4 YPbPr/RGB terminal (BNC)<sup>\*1\*2</sup>

IN : This is the YPbPr/RGB signal input terminal.  
OUT : This is the input signal through-out terminal.  
\* When using the RGB signal, you can also connect the external synchronizing signal to the SYNC/HD terminal. When using a PC RGB signal, connect the horizontal synchronizing signal to the SYNC/HD terminal, and the vertical synchronizing signal to the VD terminal.

### 5 VD IN input terminal

This is the vertical synchronizing signal (VD) input terminal used when connecting to a PC RGB signal.

### 6 AUDIO input terminal (pin jack)

This is the common audio input terminal for all video input terminals.  
\* SDI input audio is automatically selected by selecting [SDI1] or [SDI2] with [INPUT SELECT].

### 7 HEADPHONES output connector (Stereo mini-jack M3)

Connect a pair of headphones to monitor the sound.  
\* The sound volume and sound quality will depend on the headphones. Note that plugging in a pair of headphones turns off the speakers.

### 8 GPI input terminal (D-SUB 9-pin)

External control is possible by using a GPI signal.

### 9 RS232C input terminal (D-SUB 9-pin)

External control is possible by using a RS232C signal.  
\*1 Unless a cable is connected to the OUT terminal, the VIDEO IN terminal is automatically terminated at 75Ω. Connecting a cable releases this termination.  
\*2 Since a connection to the through-out terminal releases the 75Ω termination of the unit, the level of the video signal input to the unit may become too large depending on the connected device.

# Power Supply

## Connecting and fixing the power cord

### 1. Attach the power cord to the monitor unit.

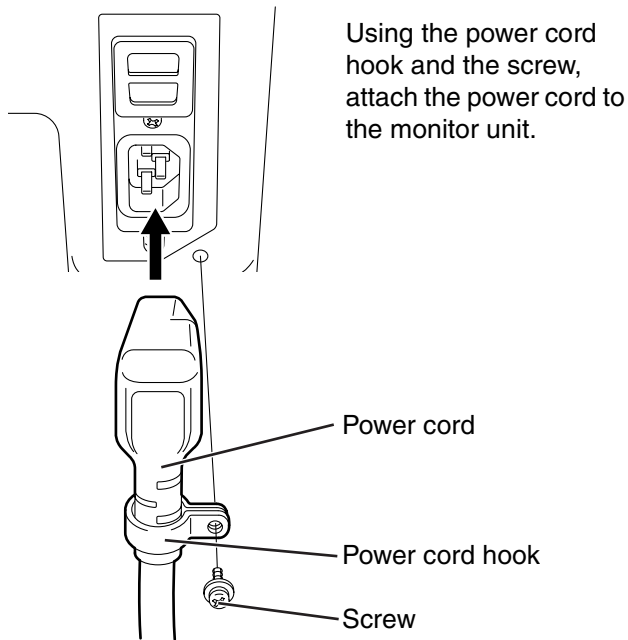

### 2. Connect the power cord to the power outlet.

### ■ When using external DC power (12V DC)

You can slide open the power cover, and switch from AC input to external DC input. (When shipped from the factory, the power cover is up, and AC input is selected.)

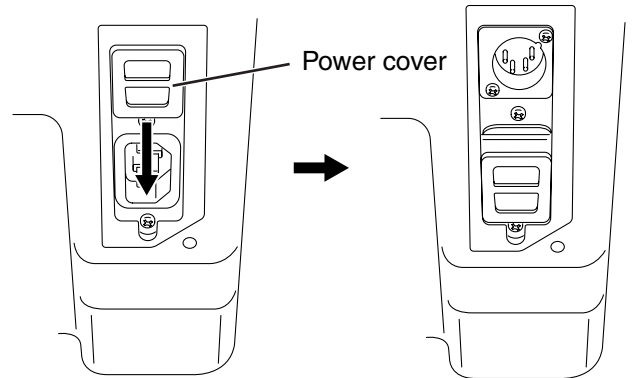

### Please note the followings

- If the power cover has been removed or opened, do not use the monitor with the power supply connected to both the AC input and external DC input terminals.
- Use a shielded DC cable that is not longer than 2 m. A cable that is 2 m or longer may cause noise.
- Use an external 12 V DC, 7 A (10 A peak or more) DC power supply.

When using external DC power (12 V DC), check the external DC input terminal pin signal, and use the correct polarity. If a +12 V power supply is accidentally connected to the GND terminal, this could cause a fire or personal injury.

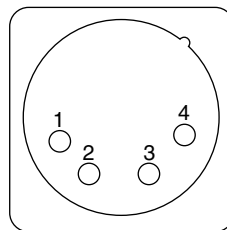

Pin number	Signal
1	GND
2, 3	—
4	+12 V

External DC input terminal

# How to Use the On Screen Menu

The screen displays eight types of information: input signal status, picture adjusting knob status, sharpness display, FUNCTION display, audio level meter display, menu display, time code display and closed caption display.

## Input signal status

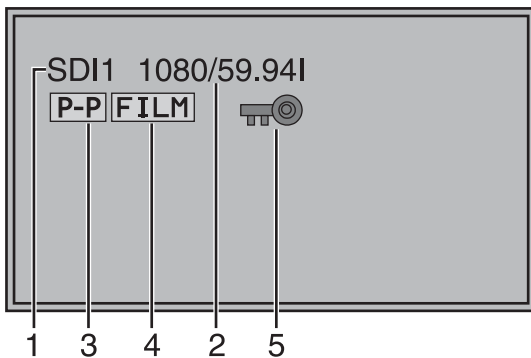

### 1. The selected input line (→ page 9, 2)

- VIDEO, SDI1, SDI2, YPbPr/RGB-VIDEO/RGB-COMP. DVI-VIDEO/DVI-COMP.

### 2. Signal format

- Use “STATUS DISPLAY” in the “SYSTEM CONFIG” menu to set the display status (→ page 22).
- “UNSUPPORT SIGNAL” appears if an unsupported signal is input. It may also indicate that the format selected in the “INPUT SELECT” menu does not match the input signal.
- “NO SIGNAL” appears if no signal is input.

### 3. Various indications (PIXEL TO PIXEL mode)

- This indicates the PIXEL TO PIXEL mode is engaged.

### 4. Various indications (FILM mode)

- This indicates that “GAMMA SELECT” is set to “FILM.”

### 5. Various indications (lock status)

- This indicates that the control lock is on.

#### Note:

“UNSUPPORT SIGNAL” and “NO SIGNAL” may not be properly displayed.

## Picture adjusting knob status

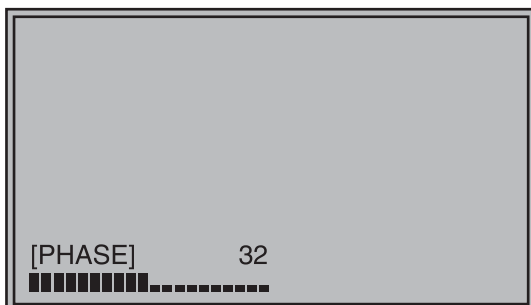

### Picture adjusting knob (→ page 9, 4)

- Press or turn this knob to make adjustments.
- The status display appears when the knob is pressed. To clear the display, press the knob again or leave it idle for 10 seconds.
- Only adjustments that appear on the screen can be adjusted.
- The display always appears in the same screen location.

Display status:

PHASE, CHROMA, BRIGHT, CONTRAST or BACKLIGHT.

#### Note:

The status of the volume knob does not appear on the screen.

## Sharpness display

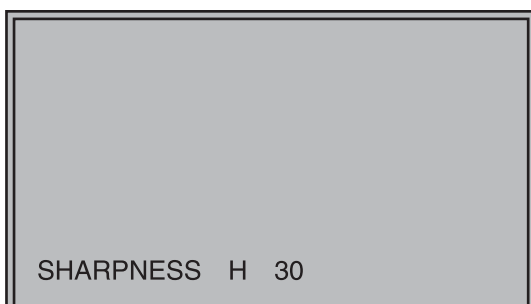

- This is the SHARPNESS H/V mode display.
- It disappears after 2 minutes of inaction.

# How to Use the On Screen Menu (continued)

## FUNCTION display

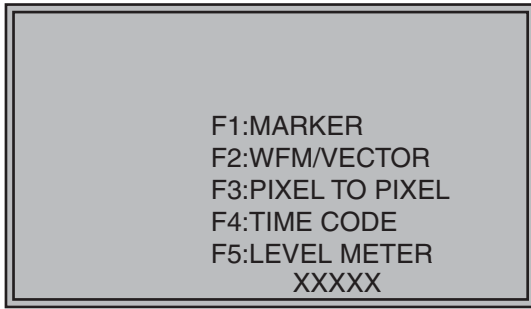

- Use the menu to open and set up functions.
- When “FUNCTION DISPLAY” (→ page 23) is set to ON, press any of the “FUNCTION1” to “FUNCTION5” buttons to display the functions assigned to the FUNCTION buttons.
- This display disappears after 2 seconds of inaction.
- “XXXXX” indicates operating status (→ page 25, “Functions displayed during FUNCTION button operation”).

## Audio level meter display

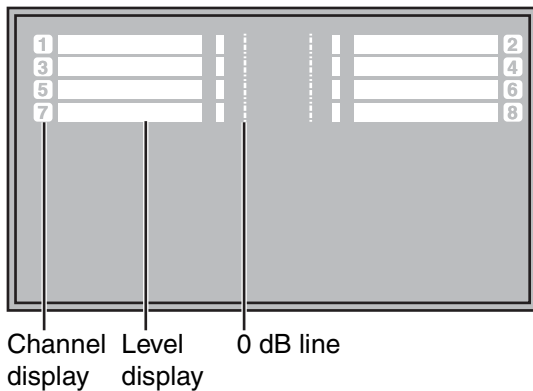

- A white skeleton bar meter indicates the audio level for SDI signals.
- You can switch the level display on/off and set the number of displayed channels using the menu.
- The 0 dB line and channel display can be switched on/off from the menu.

## Menu display

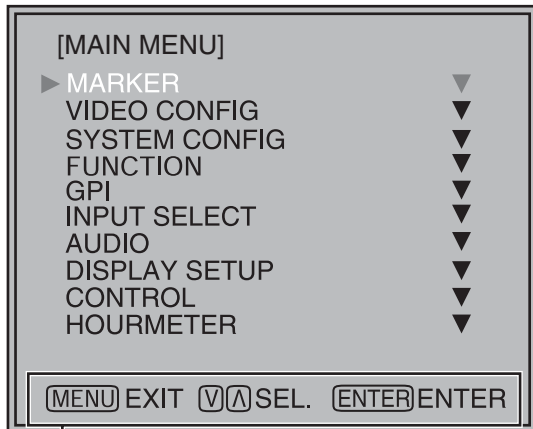

Displays instructions on menu button operations.

- This is the menu display.
- It disappears after 2 minutes of inaction.
- You can change position of the display (→ page 22, “MENU POSITION”).

# How to Use the On Screen Menu (continued)

## Time code (TC) display



( :) NDF  
( . ) DF

- Use the menu to display the time code for HD-SDI signal input. It also allows you to switch display mode (VITC, LTC, VUB, LUB).

In VITC and LTC display mode:

- Displays the time code in hours: minutes: seconds: or frames.
- In drop-frame mode, a different delimiter between seconds and frames is used.

**Note:**

Read errors are displayed as "--:--:--:--"

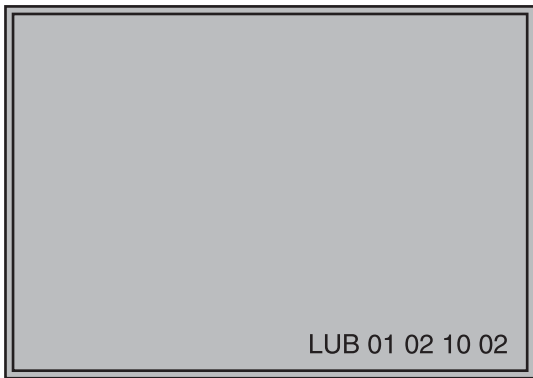

In VUB and LUB display modes:

- BG8, BG7, BG6, BG5, BG4, BG3, BG2, BG1 appear in the stated order. BG: binary group
- The (:) delimiter does not appear.

**Note:**

Read errors are displayed as "--:--:--:--"

## Closed caption (CC) display

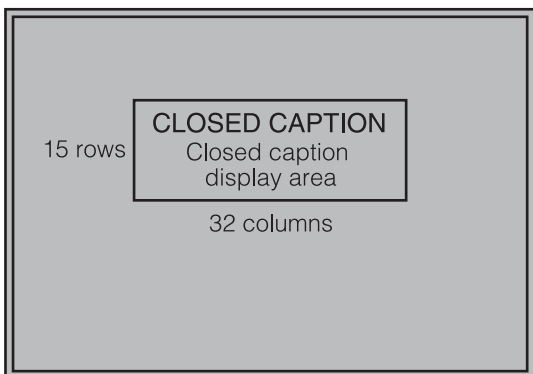

- Use the menu to display closed caption for VIDEO (NTSC) signals. It also allows you to select display mode (CC1 to CC4).

**Note:**

Closed captions are not available during HV DELAY.

# How to Use the On Screen Menu (continued)

## Menu operations

1. Press [MENU] to display the MAIN menu.

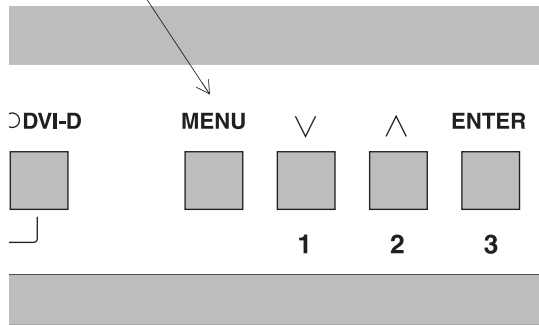

2. Press [V, ^] to select a menu and press [ENTER].

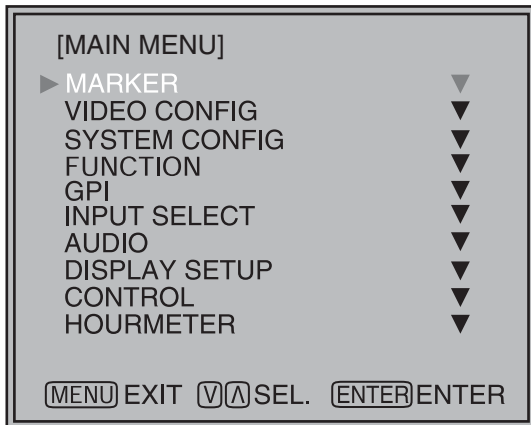

3. Press [V, ^] to select a sub menu and Press [ENTER].

The settings in the sub menu change to green.

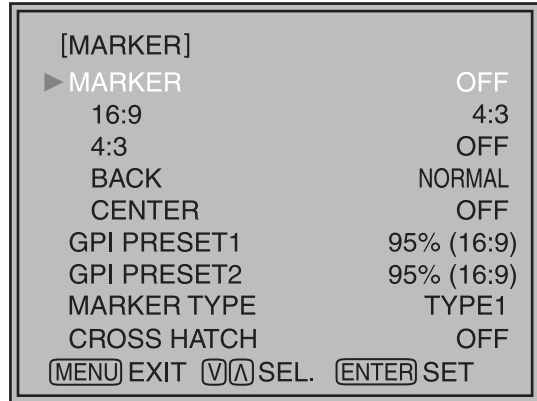

4. Press [V, ^] to select a setting, then press [ENTER].

To cancel, press [MENU].

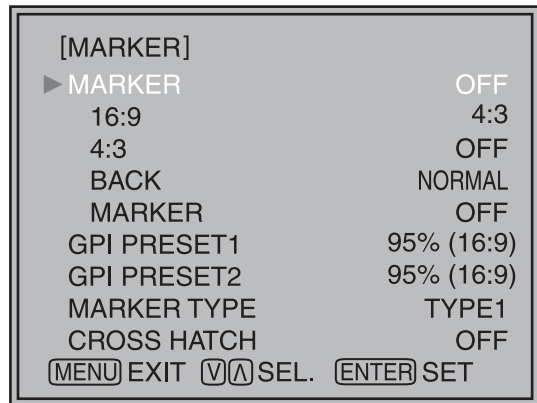

**To return to the previous screen**

Push [MENU].

# User Data

You can save and load up to five combinations of menu settings and adjustments made with the picture adjustment knob as user data. You can also return settings and adjustments to their factory defaults.

User data include the following settings.

- Menu settings except “SETUP LOAD/SAVE” (including button function settings on the monitor front panel)
- Screen adjustments made with the picture adjusting knob

## Saving user data

1. Press [MENU] to display the MAIN menu.
2. Press [V, ^] to select the “SYSTEM CONFIG” menu and press [ENTER].
3. Press [V, ^] to select the “SETUP SAVE” sub menu and press [ENTER].

The setting in the sub menu changes to green.

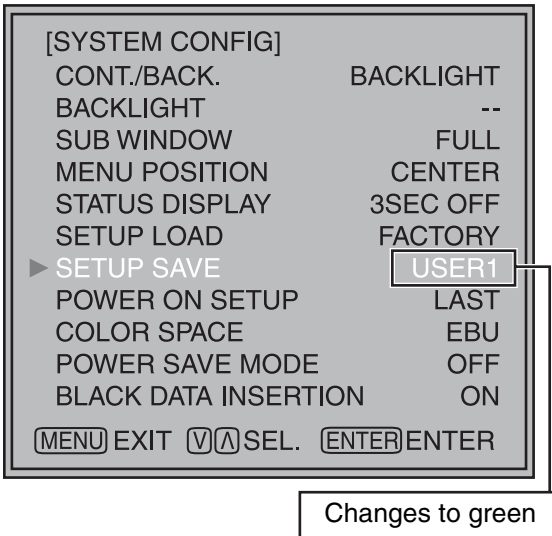

## Loading user data

1. Press [MENU] to display the MAIN menu.
2. Press [V, ^] to select the “SYSTEM CONFIG” menu and press [ENTER].
3. Press [V, ^] to select the “SETUP LOAD” sub menu and press [ENTER].

The setting in the sub menu changes to green.

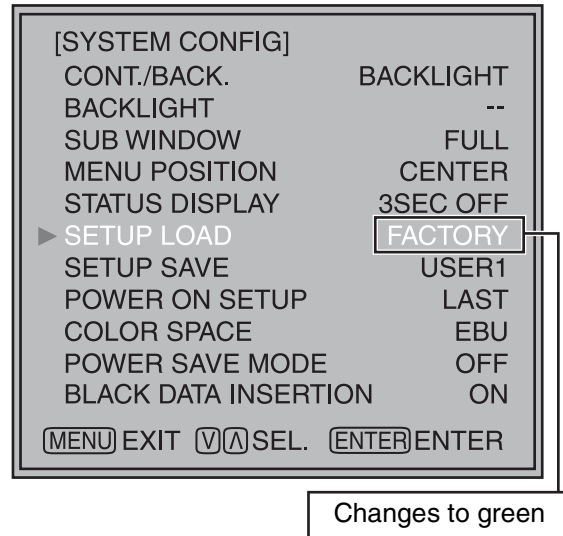

4. Press [V, ^] to select a “USER1” to “USER5” file to save the settings to and press [ENTER].

The following screen appears.

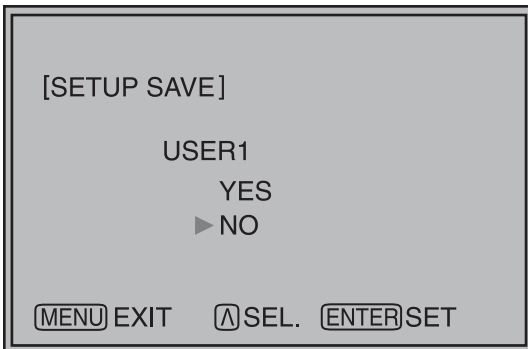

5. Select “YES” and press [ENTER].

This saves the user data.

4. Press [V, ^] to select a “USER1” to “USER5” file to load and press [ENTER].

The following screen appears.

To return to the factory defaults, select “FACTORY.”

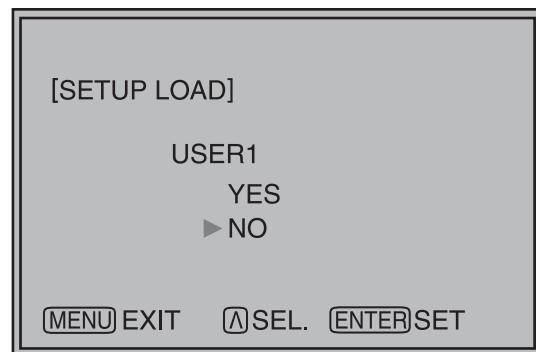

5. Select “YES” and press [ENTER].

This loads the user data.

**To return to the previous screen**

Push [MENU].



# Main Menu

## Menu configuration

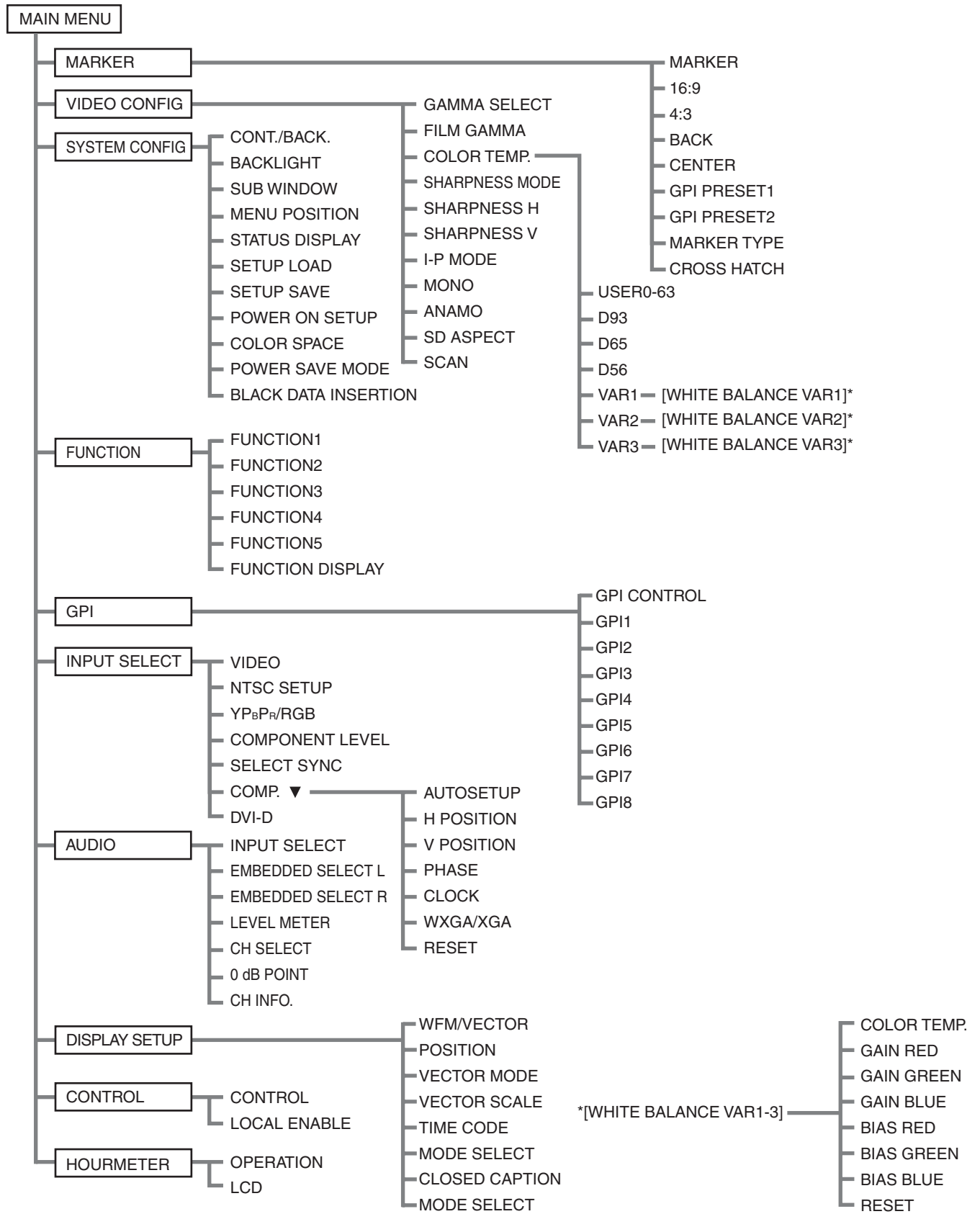

# Main Menu (continued)

## MARKER

Underlined values indicate factory defaults.

Sub menu	Setting	Description
<b>MARKER</b>	<u>OFF</u> <sup>*1</sup> ON	Enables the MARKER setting.
<b>16:9</b> <sup>*2*3</sup>	OFF <u>4:3</u> 13:9 14:9 CNSCO VISTA 95% 93% 90% 88% 80%	Selects and displays marker type for 16:9 aspect ratio. <OFF> No marker display <4:3> 4:3 marker <13:9> 13:9 marker <14:9> 14:9 marker <CNSCO> CNSCO marker <VISTA> VISTA marker <95%> 95% area marker <90%> 90% area marker <80%> 80% area marker <93%> 93.1% area marker (TYPE1) <93%> 93% area marker (TYPE2) <88%> 89.5% area marker (TYPE1) <88%> 88% area marker (TYPE2)
<b>4:3</b> <sup>*2*4</sup>	<u>OFF</u> 95% 93% 90% 88% 80%	Selects and displays marker type for 4:3 aspect ratio. <OFF> No marker display <95%> 95% area marker <93%> 93% area marker <90%> 90% area marker <80%> 80% area marker <88%> 89% area marker (TYPE1) <88%> 88% area marker (TYPE2)
<b>BACK</b> <sup>*2</sup>	<u>NORMAL</u> HALF BLACK	Selects the background brightness around the marker. <NORMAL> Normal background <HALF> 50% background brightness <BLACK> 0% background brightness (black)
<b>CENTER</b> <sup>*2</sup>	<u>OFF</u> ON	Displays the center marker. <OFF> Turns the display off <ON> Turns the display on
<b>GPI PRESET1</b> <sup>*5</sup>	4:3 13:9 14:9 CNSCO VISTA	GPI PRESET1: Selects the marker displayed by the GPI terminal "MARKER1 ON/OFF" (→ page 36) operation. GPI PRESET2: Selects the marker displayed by the GPI terminal "MARKER2 ON/OFF" (→ page 36) operation. <4:3> 4:3 marker <13:9> 13:9 marker <14:9> 14:9 marker <CNSCO> CNSCO marker <VISTA> VISTA marker
<b>GPI PRESET2</b> <sup>*5</sup>	<u>95% (16:9)</u> 93% (16:9) 90% (16:9) 88% (16:9) 80% (16:9) 95% (4:3) 93% (4:3) 90% (4:3) 88% (4:3) 80% (4:3)	
<b>MARKER TYPE</b> <sup>*6</sup>	<u>TYPE1</u> TYPE2	Selects conventional monitor or camera recorder marker size. <TYPE1> Conventional monitor marker size <TYPE2> Marker size compliant with the camera recorder (Panasonic)
<b>CROSS HATCH</b>	HIGH LOW <u>OFF</u>	Turns the cross hatch grid on and off and sets its density. <HIGH> 70/256 (displays a dense cross hatch grid) <LOW> 20/256 (displays a light cross hatch grid) <OFF> Turns the display off

\*1 This setting is turned "ON" when receiving marker control in REMOTE operation. (GPI, if set, has priority.)

\*2 These settings are disabled when the GPI function (→ page 36) is used to control the marker setting. They are also disabled in split screen mode.

\*3 This setting is enabled only for HD and SD signal input in 16:9 aspect ratio mode.

\*4 This setting is enabled for SD signal input in 4:3 aspect ratio mode.

\*5 Remote control via RS-232C ends in error (error response: ER001) when "GPI PRESET1" or "GPI PRESET2" is selected with the GPI function.

\*6 Display size for SD signals differ.

TYPE1: The effective horizontal area meets the SMPTE125M for NTSC and ITU-R BT 601-5 for PAL.

TYPE2: The effective horizontal area meets the EIA-RS170 for NTSC and ITU-R BT 470-4 for PAL.

# Main Menu (continued)

## Marker types

### 16:9 marker (Displayed for HD input and SD input in 16:9 ratio mode.)

This marker is only displayed as a vertical bar. The  section becomes the "MARKER BACK".

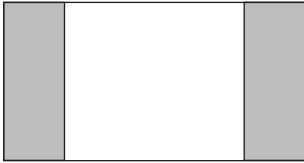

4:3 marker



13:9 marker



14:9 marker

### VISTA marker, CNSCO marker

This marker is displayed as a horizontal dotted line.

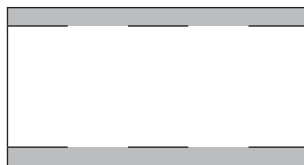

VISTA marker



CNSCO marker

The marker is displayed as a vertical dotted line when "UNDER" is selected under "SCAN" in the "VIDEO CONFIG" menu.



VISTA marker

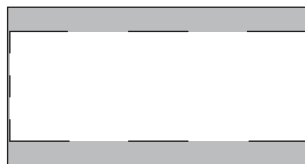

CNSCO marker

### Area marker

This marker is displayed as a dotted line.



95% Area marker

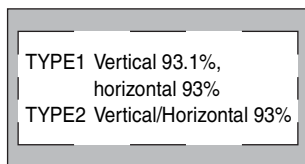

93% Area marker

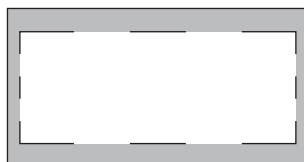

90% Area marker

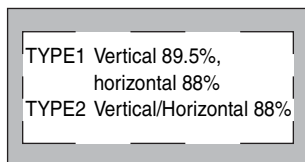

88% Area marker



80% Area marker

### 4:3 marker (Displayed for SD input in 4:3 aspect ratio mode)

This marker is displayed as a dotted line.

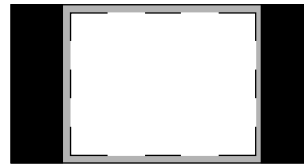

95% Area marker

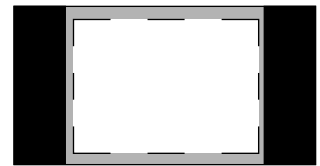

93% Area marker

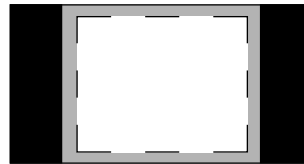

90% Area marker

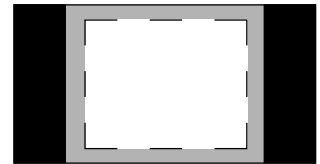

88% Area marker

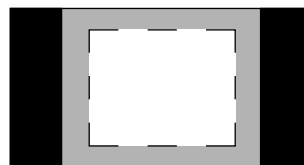

80% Area marker

### (Displayed for HD input and SD input in 16:9 ratio mode.)

This marker is displayed as a dotted line.

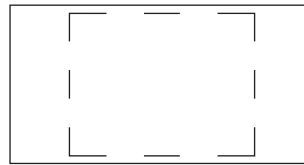

95% Area marker

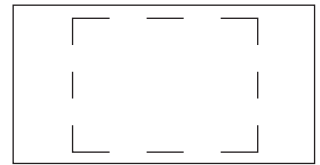

93% Area marker

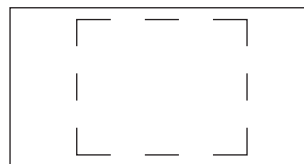

90% Area marker

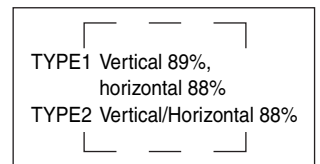

88% Area marker

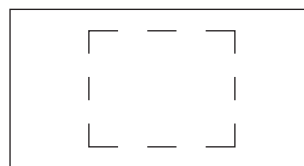

80% Area marker

\* You can display the 4:3 marker and the 16:9 marker simultaneously. Simultaneous display example

The  section becomes the "MARKER BACK". It controls the background of the marker selected with a 16:9 ratio.

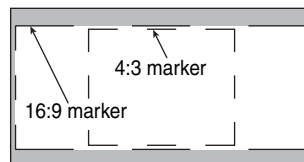

16:9 marker:  
95% area marker  
4:3 marker:  
80% area marker

### Center marker

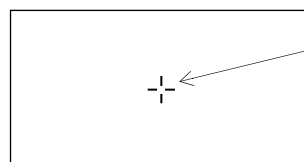

Center marker  
This marker is displayed at the center of the screen.

# Main Menu (continued)

## VIDEO CONFIG

Underlined values indicate factory defaults.

Sub menu	Settings	Description
<b>GAMMA SELECT</b> <sup>*1*2</sup>	STANDARD FILM <u>STDIO/PST</u>	Selects gamma curve. <STANDARD> Standard mode    <FILM> Film mode <STDIO/PST> Color emphasis mode (a mode that approximates CRT display capability suitable for studio or postproduction application) The <b>FILM</b> mark appears at the top left of the screen when "FILM" is selected.
<b>FILM GAMMA</b> <sup>*2</sup>	<u>VARICAM</u> OTHER	Selects type of FILM gamma mode. <VARICAM> For VARICAM use    <OTHER> Other
<b>COLOR TEMP.</b>	USER0 - 63 <sup>*5</sup> D93 <u>D65</u> D56 VAR1 VAR2 VAR3	Selects color temperature. <USER 0 - 63> Adjustable settings 0 - 63 (equivalent to a color temperature range of 3,000 - 9,300K) <D93> Equivalent to a color temperature of 9,300K <D65> Equivalent to a color temperature of 6,500K <D56> Equivalent to a color temperature of 5,600K <VAR1> WB adjustment mode <sup>*4</sup> <VAR2> WB adjustment mode <sup>*4</sup> <VAR3> WB adjustment mode <sup>*4</sup>
<b>SHARPNESS MODE</b> <sup>*2</sup>	HIGH <sup>*3</sup> LOW	Selects the width of outline correction edge. <HIGH> Thin edge    <LOW> Wide edge
<b>SHARPNESS H</b> <sup>*2</sup>	0 - 30 <sup>*3</sup>	Sets horizontal outline correction. The item display moves to the lower part of the screen during adjustment.
<b>SHARPNESS V</b> <sup>*2</sup>	0 - 30 <sup>*3</sup>	Sets vertical outline correction. The item display moves to the lower part of the screen during adjustment.
<b>I-P MODE</b> <sup>*2*6</sup>	MODE2 <u>MODE1</u>	Selects IP conversion mode. (→ page 21, "IP mode") <MODE2> Inter-field interpolation <MODE1> Inter-frame interpolation
<b>MONO</b> <sup>*2</sup>	<u>OFF</u> ON	Switches between color and monochrome (MONO). <OFF> Color    <ON> Monochrome * When ON, the CHROMA setting of the picture adjusting knob is fixed at 0.
<b>ANAMO</b> <sup>*2*7</sup>	<u>OFF</u> ON	With an Anamo lens and SDI 720/60P, 59.94P input, the picture is resized to Anamo magnification (the vertically enlarged signal can be vertically compressed and corrected for display).
<b>SD ASPECT</b> <sup>*2</sup>	<u>4:3</u> 16:9	Sets the aspect ratio for SD signal input. <4:3> 4:3 display    <16:9> 16:9 display
<b>SCAN</b> <sup>*2</sup>	<u>NORMAL</u> UNDER	Sets under-scan and normal display. <NORMAL> Normal display    <UNDER> Under-scan

\*1 In split-screen display, changes are not reflected to the still image in the main window.

\*2 These functions are not available when "RGB-COMP:" under "YPbPr/RGB" or "DVI-COMP:" under "DVI-D" is selected in the "INPUT SELECT" menu (→ page 30).

\*3 The following sharpness values are available and the settings for the selected input signal is displayed. Adjustment status during selection appears at the bottom right of the screen.

1) VIDEO system input (VIDEO) (the factory defaults are SHARPNESS MODE: LOW and SHARPNESS H/V: 0)

2) HD for any other input (the factory defaults are SHARPNESS MODE: HIGH and SHARPNESS H/V: 0).

3) SD for any other input (the factory defaults are SHARPNESS MODE: LOW and SHARPNESS H/V: 0).

\*4 Selecting "VAR1", "VAR2" and "VAR3" engages the WB adjustment mode (→ page 21).

\*5 To select USER0 - 63,

1) Press [ENTER] ("USER" changes to blue).

2) Use [V, ^] to select 0 - 63 and press [ENTER].

\*6 To use the "SUB WINDOW" (→ page 25) function,

1) Change settings after exiting the "SUB WINDOW" function.

2) It is recommended to use "MODE2" for handling fast video.

\*7 "SCAN" changes are not reflected in Anamo size display.

## Main Menu (continued)

### IP mode

“MODE1” performs IP conversion using inter-frame interpolation.

Conventional inter-frame interpolation involved 1-frame or greater delay, but this monitor suppresses the delay to within 1 field.

The factory default is “MODE1”.

“MODE2” performs IP conversion using inter-field interpolation.

Since interpolation is performed inside each field, this mode is suitable for checking interlace status.

### ■ WB adjustment mode

Select “VAR1” to “VAR3” for “COLOR TEMP.” in the “VIDEO CONFIG” menu to make “WHITE BALANCE VAR1” to “WHITE BALANCE VAR3” (WB) adjustments.

Underlined values indicate factory defaults.

Sub menu	Settings	Description
<b>COLOR TEMP.</b> <sup>*1</sup>	USER0 - 6 D93 <u>D65</u> D56	Selects the color temperature that will become the basis for adjustment. <USER 0 - 63> Adjustable settings 0 - 63 (equivalent to a color temperature range of 3,000 - 9,300K) <D93> Equivalent to a color temperature of 9,300K <D65> Equivalent to a color temperature of 6,500K <D56> Equivalent to a color temperature of 5,600K
<b>GAIN RED</b>	0 - 1023 (Factory defaults are color temperature <D65> values.) * These are the adjustments made before shipment from the factory.	Adjusts the GAIN elements for RED. <sup>*2</sup>
<b>GAIN GREEN</b>		Adjusts the GAIN elements for GREEN. <sup>*2</sup>
<b>GAIN BLUE</b>		Adjusts the GAIN elements for BLUE. <sup>*2</sup>
<b>BIAS RED</b>	-512 - 511 (Factory default: 0)	Adjusts the BIAS elements for RED. <sup>*2</sup>
<b>BIAS GREEN</b>		Adjusts the BIAS elements for GREEN. <sup>*2</sup>
<b>BIAS BLUE</b>		Adjusts the BIAS elements for BLUE. <sup>*2</sup>
<b>RESET</b>		Resets “GAIN RED” - “BIAS BLUE” to color temperature values selected under “COLOR TEMP.”

\*1 Selecting “COLOR TEMP.” and pressing [ENTER] after making a change, opens a confirmation screen. Selecting “YES” and pressing [ENTER] in this screen resets selected GAIN and BIAS values to the selected color temperature values.

\*2 The item display moves to the lower part of the screen during adjustment.



## Main Menu (continued)

### FUNCTION

Underlined values indicate factory defaults.

Sub menu	Settings	Description
<b>FUNCTION 1 - FUNCTION 5</b>	HV DELAY AUTOSETUP BLUE ONLY GAMMA SELECT SD ASPECT SCAN SUB WINDOW WFM/VECTOR MARKER PIXEL TO PIXEL PIXEL POSITION LEVEL METER CROSS HATCH MONO TIME CODE CLOSED CAPTION UNDEF  (Factory default: FUNCTION1: MARKER FUNCTION2: WFM/VECTOR FUNCTION3: PIXEL TO PIXEL FUNCTION4: TIME CODE FUNCTION5: LEVEL METER)	Selects functions to be assigned to [FUNCTION1] - [FUNCTION5] (front panel buttons). <HV DELAY> Displays synchronizing signals (horizontal, vertical). The display changes in the following order. DELAY OFF → V DELAY → H DELAY → HV DELAY → DELAY OFF <AUTOSETUP> Performs auto setup for PC display. <BLUE ONLY> Cuts the red and green signals. Use this function to check phase and chroma. This button toggles between ON and OFF. <GAMMA SELECT>* <sup>1</sup> Displays the gamma curve. The display changes in the following order. GAMMA STANDARD → GAMMA FILM → GAMMA STUDIO/PST → GAMMA STANDARD <SD ASPECT> Switches between "16:9" and "4:3".* <sup>1</sup> <SCAN> Switches between "UNDER SCAN" and "NORMAL SCAN".* <sup>1</sup> <SUB WINDOW> Sets the split-screen function.* <sup>1</sup> The display changes in the following order. SINGLE → FULL/PART → STILL → SINGLE <WFM/VECTOR> Displays waveform or vector display. <MARKER> Turns the marker on and off. <PIXEL TO PIXEL> Turns the PIXEL TO PIXEL function On and Off. <PIXEL POSITION> Positions the display of signals in PIXEL TO PIXEL mode. <LEVEL METER> Turns the LEVEL METER display On and Off. <TIME CODE> Turns the time code display on and off. <MONO> Switches between color and monochrome. <CLOSED CAPTION> Turns the closed caption display on and off. <UNDEF> Undefined
<b>FUNCTION DISPLAY</b>	OFF ON1 <u>ON2</u>	Selects display of functions assigned to [FUNCTION1] - [FUNCTION5] (front panel buttons). It also selects button action (1-touch, 2-touch, off). <ON1> 1-touch action to display and perform functions. <ON2> 2-touch action to display and perform functions. <OFF> No function display.

\*1 Changes in settings change menu settings.

## Main Menu (continued)

### ■ FUNCTION setting restrictions

Settings are not available under the following conditions.

Setting	Conditions that disable operation
<b>HV DELAY</b>	During SUB WINDOW, WFM, PIXEL TO PIXEL mode operation, "INVALID FUNCTION" appears to indicate that operation is disabled. When "RGB-COMP." is selected under "YP <sub>B</sub> PR/RGB" or "DVI-COMP." is selected under "DVI-D" in the "INPUT SELECT" menu, "INVALID FUNCTION" appears to indicate that operation is disabled.
<b>AUTO SETUP</b>	When something other than "RGB-COMP." is selected under "YP <sub>B</sub> PR/RGB" in the "INPUT SELECT" menu, "NOT RGB-COMP. CH" appears to indicate that operation is disabled. When "RGB-COMP." is selected under "YP <sub>B</sub> PR/RGB" in the "INPUT SELECT" menu and no signal is input, "INCOMPLETE" appears to indicate that operation is disabled.
<b>GAMMA SELECT</b>	When GPI is set, "INVALID FUNCTION" appears to indicate that operation is disabled. When "RGB-COMP." is selected under "YP <sub>B</sub> PR/RGB" or "DVI-COMP." is selected under "DVI-D" in the "INPUT SELECT" menu, "INVALID FUNCTION" appears to indicate that operation is disabled.
<b>SD ASPECT</b>	When GPI is set, "INVALID FUNCTION" appears to indicate that operation is disabled. During SUB WINDOW (still image) and HD display (including PIXEL TO PIXEL), "INVALID FUNCTION" appears to indicate that operation is disabled.
<b>SCAN</b>	When GPI is set, "INVALID FUNCTION" appears to indicate that operation is disabled. During SUB WINDOW and PIXEL TO PIXEL mode operation, "INVALID FUNCTION" appears to indicate that operation is disabled.
<b>SUB WINDOW</b>	When "RGB-COMP." is selected under "YP <sub>B</sub> PR/RGB" or "DVI-COMP." is selected under "DVI-D" in the "INPUT SELECT" menu, "INVALID FUNCTION" appears to indicate that operation is disabled. If you select "RGB-COMP." or "DVI-COMP." while motion picture is displayed in sub-window, the screen returns to a single screen display. Selecting something other than "RGB-COMP." or "DVI-COMP." opens the split screen mode and a still image is blacked out.
<b>WFM/VECTOR</b>	During SUB WINDOW and PIXEL TO PIXEL mode operation, "INVALID FUNCTION" appears to indicate that operation is disabled. When "RGB-COMP." or "RGB-VIDEO" is selected under "YP <sub>B</sub> PR/RGB", or "DVI-COMP." or "DVI-VIDEO" is selected under "DVI-D" in the "INPUT SELECT" menu, "INVALID FUNCTION" appears to indicate that WFM operation is disabled. 1080/23P, 24P, 25P, 29P or 30P input causes "INVALID FUNCTION" to appear indicating that operation is disabled, VECTOR does not appear when a selection other than "SDI" is made in the "INPUT SELECT" menu.
<b>MARKER</b>	When "RGB-COMP." is selected under "YP <sub>B</sub> PR/RGB" or "DVI-COMP." is selected under "DVI-D" in the "INPUT SELECT" menu, "INVALID FUNCTION" appears to indicate that operation is disabled. When GPI is set during sub-window operation, "INVALID FUNCTION" appears to indicate that operation is disabled.
<b>PIXEL TO PIXEL</b>	When "SD1" or "SD2" is selected in the "INPUT SELECT" menu during 1080I/P signal input or "YP <sub>B</sub> PR" is selected in "YP <sub>B</sub> PR/RGB", 1080I/P signal input is enabled. When other settings are made, "INVALID FUNCTION" appears to indicate that operation is disabled. In SUB WINDOW mode, "INVALID FUNCTION" appears to indicate that operation is disabled.
<b>LEVEL METER</b>	When input is something other than SDI, "INVALID FUNCTION" appears to indicate that operation is disabled.
<b>MONO</b>	When GPI is set, "INVALID FUNCTION" appears to indicate that operation is disabled.
<b>TIMECODE</b>	When input is something other than HD-SDI input, "INVALID FUNCTION" appears to indicate that operation is disabled.



# Main Menu (continued)

## ■ Functions displayed during FUNCTION button operation

Pressing any of the [FUNCTION1] to [FUNCTION5] buttons displays the operations assigned to each button as shown below.

- **HV DELAY**  
DELAY OFF/V DELAY/H DELAY/HV DELAY
- **AUTOSETUP**  
AUTOSETUP/COMPLETE/INCOMPLETE/NOT  
RGB-COMP.CH
- **BLUE ONLY**  
BLUE ONLY ON/BLUE ONLY OFF
- **GAMMA SELECT**  
GAMMA STANDARD/GAMMA FILM/GAMMA  
STUDIO/PST
- **SD ASPECT**  
4:3/16:9
- **SCAN**  
NORMAL SCAN/UNDER SCAN
- **SUB WINDOW**  
SINGLE/FULL/PART/STILL
- **WFM/VECTOR**  
WFM ON/WFM/VECTOR OFF/VECTOR × 1/  
VECTOR × 2/VECTOR × 4/VECTOR × 8
- **MARKER**  
MARKER OFF/4:3 MARKER/13:9 MARKER/14:9  
MARKER/VISTA MARKER/CNSCO MARKER/95%  
MARKER/93% MARKER/90% MARKER/88%  
MARKER/80% MARKER/MARKER ON
- **PIXEL TO PIXEL**
- **PIXEL POSITION**  
CENTER/LEFT TOP/LEFT BOTTOM/RIGHT TOP/  
RIGHT BOTTOM/PIXEL TO PIXEL OFF
- **AUDIO LEVEL METER**  
METER OFF/METER 2CH/METER 4CH/METER  
8CH
- **CROSS HATCH**  
CROSS HATCH HIGH/CROSS HATCH LOW/  
CROSS HATCH OFF
- **MONO**  
MONO ON/MONO OFF
- **TIME CODE**  
LTC/VITC/LUB/VUB/TC OFF
- **CLOSED CAPTION**  
CC1/CC2/CC3/CC4/CC OFF

## ■ “HV DELAY”

This displays the blanking period. Each press of the button changes the display as follows: H blanking display → V blanking display → H and V blanking display → no blanking display.

## ■ “SUB WINDOW”

Opening the “SUB WINDOW” function splits the screen (main window) in two as shown below to enable comparison of a recorded still image with live video.

Use the “SUB WINDOW” setting (FULL, PART) in the “SYSTEM CONFIG” menu (→ page 22) to set up the function as shown below.

Press the button ([FUNCTION1] to [FUNCTION5]) (→ page 23)) to which the “SUB WINDOW” function has been assigned to turn the function on and off. (This assumes that the “SUB WINDOW” function has been assigned to any of the [FUNCTION1] to [FUNCTION5] buttons.)

To setup “IP MODE” (→ page 20), exit the “SUB WINDOW” function first.

## • FULL

Resizes the main window to also display a second window (two sub-windows).

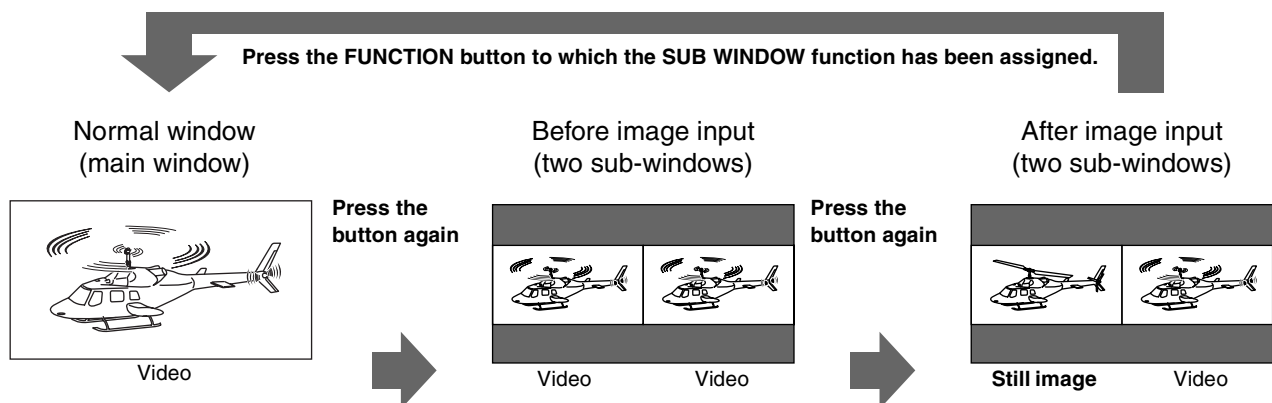

# Main Menu (continued)

## • PART

Resizes the main window to show only its center to also display a second image (two sub-windows).

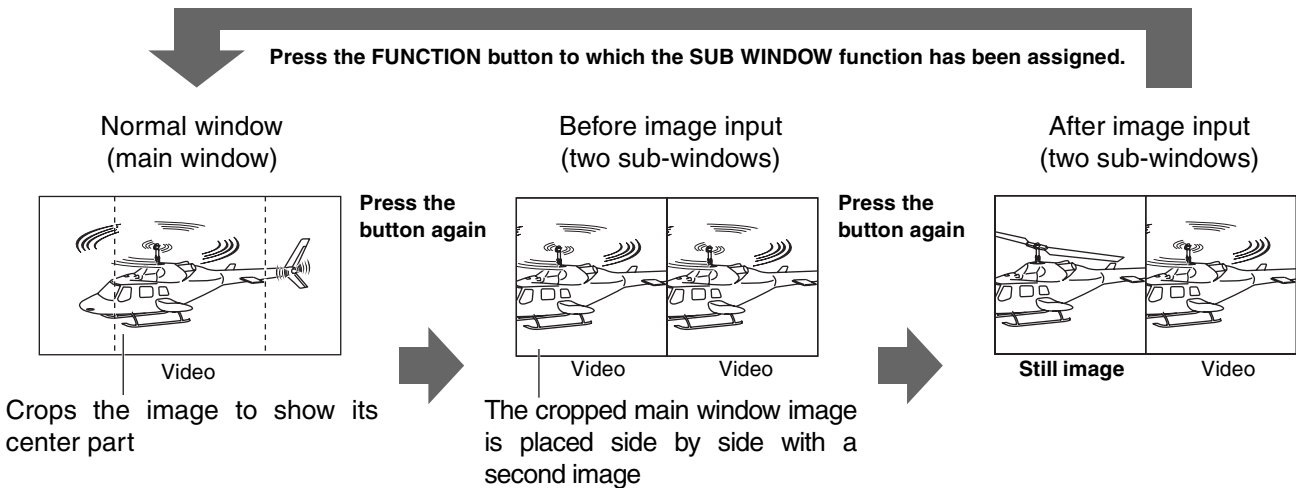

These examples show 16:9 aspect ratio images.

### Note on FULL/PART selection

This function is designed to enable comparison of identical formats input to the same input terminal. Input of different formats via different input channels may distort the sub-window (left side, still image) or blanking could occur. However, input of an identical format signal to the input terminal during still image acquisition will display correctly.

## ■ “WFM/VECTOR”

The “WFM/VECTOR” function enables display of the waveform and vector display. Use “DISPLAY SETUP” in the main menu to select “WFM” and “VECTOR” display. (→ page 33)

Press the button ([FUNCTION1] to [FUNCTION5] (→ page 23)) to which the “WFM/VECTOR” function has been assigned to turn the function on and off. (This assumes that the “WFM/VECTOR” function has been assigned to any of the [FUNCTION1] to [FUNCTION5] buttons.)

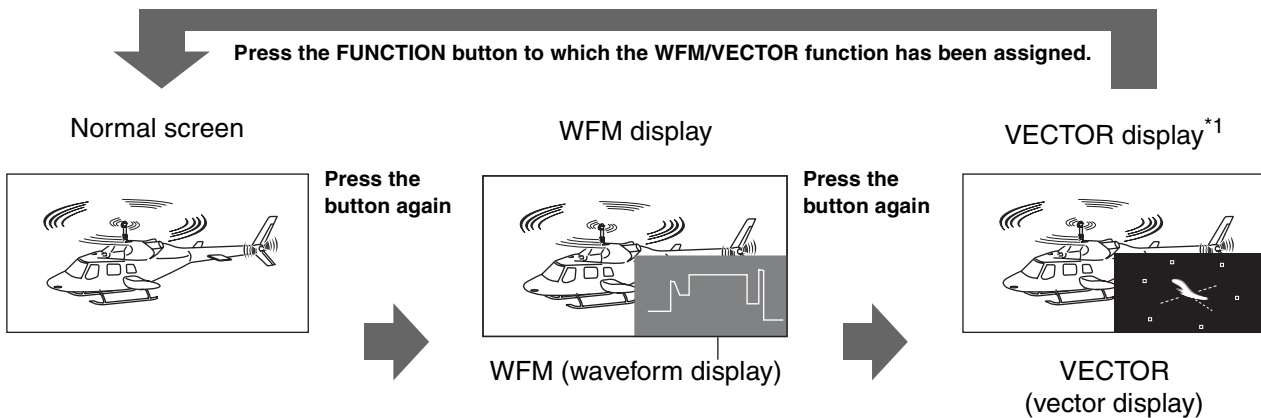

These examples show 16:9 aspect ratio images.

\*1 Displayed only for SDI signal input.

## Main Menu (continued)

### ■ “PIXEL TO PIXEL” and “PIXEL POSITION”

The “PIXEL TO PIXEL” function allows you to check images at their actual pixel resolution (1080i/P signals only). Press the button ([FUNCTION1] to [FUNCTION5] (→ page 23)) to which the “PIXEL TO PIXEL” function has been assigned to turn the function on. Then press the button ([FUNCTION1] to [FUNCTION5] (→ page 23)) to which the “PIXEL POSITION” function has been assigned to position the display of signals. (This assumes that the “PIXEL TO PIXEL” and “PIXEL POSITION” functions have been assigned to any of the [FUNCTION1] to [FUNCTION5] buttons.)

Underlined values indicate factory defaults.

Sub menu	Settings	Description
<b>PIXEL TO PIXEL</b> *1*2	<u>OFF</u> ON	Tailors the image display size to the input signal size. Compatible formats 1080/60I/59I/50I/60P/59P/50P/30P/29P/25P/24P/23P/24Psf/23Psf
<b>PIXEL POSITION</b>	<u>CENTER</u> LEFT TOP RIGHT TOP RIGHT BOTTOM LEFT BOTTOM	Positions the display of signals in PIXEL TO PIXEL mode. <CENTER> Center of the screen <LT> Left Top <RT> Right Top <RB> Right Bottom <LB> Left Bottom

\*1 The following settings are disabled in PIXEL TO PIXEL mode.

Setting “ANAMO” to “ON”, and setting “SCAN” to “UNDER” in “VIDEO CONFIG”

Any “HV DELAY” setting in “FUNCTION”

“MARKER” display

\*2 Enabled during “SDI1”, “SDI2” and “YPbPr” input.

### ■ “PIXEL POSITION” display position sequence

PIXEL POSITION: ① → ② → ③ → ④ → ⑤ → ① ………

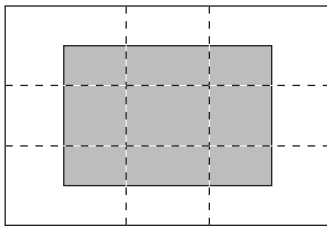

① CENTER

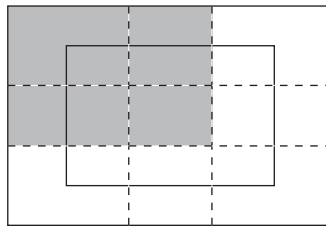

② LEFT TOP

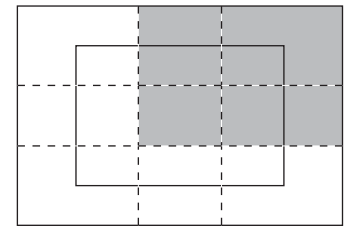

③ RIGHT TOP

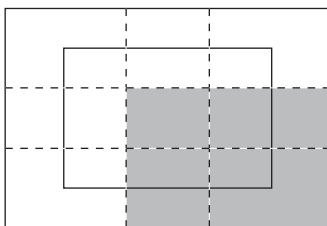

④ RIGHT BOTTOM

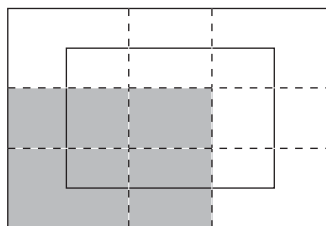

⑤ LEFT BOTTOM

## Main Menu (continued)

### ■ “CROSS HATCH”

The “CROSS HATCH” function enables display of markers at regular vertical and horizontal intervals to facilitate composition and other tasks. The width of marker lines is 1 dot, the markers consist of 1 line, and are spaced 80 dots apart (fixed value).

Each press of the button (“FUNCTION1” to “FUNCTION5”) to which the “CROSS HATCH” has been assigned turns the function on and off.

Each press of the FUNCTION button to which the “CROSS HATCH” function is assigned changes the display as shown.

#### HD/SD (16:9) mode



1st press

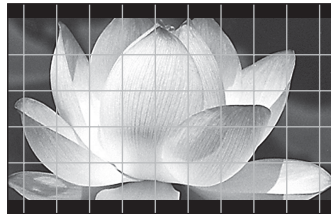

2nd press

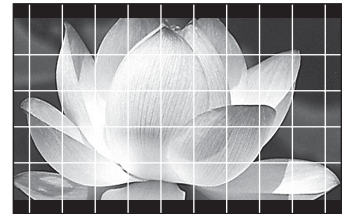

#### SD (4:3) mode



Light cross hatch

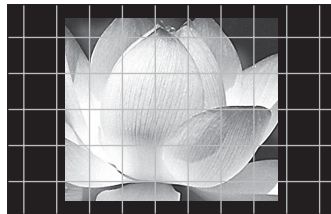

Dense cross hatch

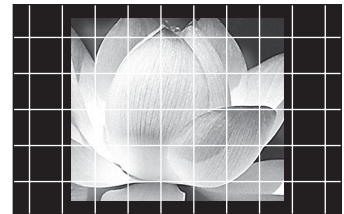

3rd press (back to original image without cross hatch)

## Main Menu (continued)

### GPI

“GPI CONTROL” is used to enable and disable GPI functions and assign functions to each of the GPI terminal pins (→ page 36).

Underlined values indicate factory defaults.

Sub menu	Settings	Description
<b>GPI CONTROL</b>	<u>DISABLE</u> ENABLE	Enables and disables GPI functions <DISABLE> Disabled <ENABLE> Enabled
<b>GPI1 - GPI8</b>	<u>UNDEF</u> MARKER1 ON/OFF MARKER2 ON/OFF MARKER BACK HALF MARKER BACK BLACK CENTER MARKER INPUT SEL. VIDEO INPUT SEL. SDI1 INPUT SEL. SDI2 INPUT SEL. YP <sub>B</sub> P <sub>R</sub> /RGB INPUT SEL. DVI-D SD ASPECT SCAN R-TALLY G-TALLY MONO GAMMA SEL. FILM GAMMA SEL. STDIO/PST SELECT SYNC PIXEL TO PIXEL	Assigns functions to the GPI control terminal pins. The same items can be set to each terminal (→ page 36).

**Note:**

This function is not available when,

- “SD ASPECT” operation when input signal is HD or PC
- “SCAN” operation when the input signal is PC
- “GAMMA SELECT” operation when the input signal is PC
- “SELECT SYNC” operation when anything other than “RGB-VIDEO” is selected under “YP<sub>B</sub>P<sub>R</sub>/RGB” in the “INPUT SELECT” menu
- “MONO” operation when input signal is PC

## Main Menu (continued)

### INPUT SELECT

Underlined values indicate factory defaults.

Sub menu	Settings	Description
<b>VIDEO</b>	<u>AUTO</u> NTSC PAL	Selects the video input format.*1 <AUTO> Automatically selects NTSC or PAL. <NTSC> NTSC                      <PAL> PAL
<b>NTSC SETUP</b>	75 <u>00</u>	Selects NTSC setup level. <75>                      Select this function when using 7.5% setup signals. (Adjusts the interior of the monitor to the 7.5% setup level to suit the black level) <00>                      Select this when there is no setup signal.
<b>YP<sub>B</sub>P<sub>R</sub>/RGB</b>	<u>YP<sub>B</sub>P<sub>R</sub></u> RGB-VIDEO RGB-COMP.	Selects YP <sub>B</sub> P <sub>R</sub> (component) or RGB input mode. <YP <sub>B</sub> P <sub>R</sub> >                Selects the YP <sub>B</sub> P <sub>R</sub> signal. <RGB-VIDEO> Selects the video RGB signal. <RGB-COMP.> Selects the PC RGB signal.
<b>COMPONENT LEVEL</b>	<u>SMPTE</u> B75 B00	Selects YP <sub>B</sub> P <sub>R</sub> (component) signal input level. <SMPTE>                Signal level complies with SMPTE and P <sub>B</sub> and P <sub>R</sub> are 0.7 Vp-p at 100% chroma. <B75>                      Select this when connecting a Betacam or similar device with a setup function. (Adjusts the interior of the monitor to the 7.5% setup level to suit the black level) <B00>                      Select this when connecting a Betacam or similar device without a setup function.
<b>SELECT SYNC</b>	<u>INT</u> EXT	Selects the sync signal when using YP <sub>B</sub> P <sub>R</sub> and RGB-VIDEO input. <INT>                      Select when the synchronizing signal is superimposed on the G or Y signal. <EXT>                      Select to synchronize with an external synchronizing signal.
<b>COMP.</b>	▼	Performs analog PC settings. ("COMP" → page 31)
<b>DVI-D</b>	<u>DVI-VIDEO</u> DVI-COMP.	Selects DVI-D input mode. <DVI-VIDEO> Selects component input. <DVI-COMP.> Selects PC input.

\*1 "AUTO" is the factory default, but select a specific format when there is risk that the input signal may be contaminated by outside noise.

## Main Menu (continued)

### ■ COMP.

Selecting “RGB-COMP.” under “YP<sub>B</sub>P<sub>R</sub>/RGB” in the “INPUT SELECT” menu opens the following menu.

Underlined values indicate factory defaults.

Sub menu	Settings	Description
<b>AUTOSETUP</b> *1		Selecting “RGB-COMP.” under “YP <sub>B</sub> P <sub>R</sub> /RGB” in the “INPUT SELECT” menu automatically adjusts the screen. A separate screen opens. Select “YES” to perform “AUTOSETUP.”
<b>H POSITION</b>	0 - 60 (Factory preset settings: 30)	Adjusts horizontal image display position.*2
<b>V POSITION</b>	0 - 60 (Factory preset settings: 30)	Adjusts vertical image display position.*2
<b>PHASE</b>	0 - 31 (Factory preset settings: 16)	Adjusts the clock phase in 1/32 clock period increments.*2
<b>CLOCK</b>	700 - 1800 (Factory preset settings:*3)	Adjusts the sampling clock in dot units.*2
<b>WXGA/XGA</b>	<u>XGA</u> WXGA	Switches between WXGA and XGA.
<b>RESET</b>		Returns “H POSITION”, “V POSITION”, “PHASE” and “CLOCK” settings in the COMP. input compliant format to their factory defaults.

\*1 “EXECUTING” is displayed during “AUTOSETUP” and “COMPLETE” appears when setup completes. “INCOMPLETE” is displayed if setup could not be completed.

AUTOSETUP may not provide adequate adjustment for some video input. Use H POSITION, V POSITION, PHASE and CLOCK to adjust.

\*2 Each input format can be adjusted but not when user data is loaded (“SETUP LOAD” → page 22) or saved (“SETUP SAVE” → page 22).

\*3 “CLOCK” factory default

FORMAT	CLOCK	FORMAT	CLOCK
640 × 400 (70 Hz)	800	1024 × 768 (60 Hz)	1344
640 × 480 (60 Hz)	800	1024 × 768 (70 Hz)	1328
640 × 480 (75 Hz)	840	1024 × 768 (75 Hz)	1312
640 × 480 (85 Hz)	832	1024 × 768 (85 Hz)	1376
800 × 600 (60 Hz)	1056	1280 × 768 (50 Hz)	1648
800 × 600 (70 Hz)	1040	1280 × 768 (60 Hz)	1680
800 × 600 (75 Hz)	1056	1280 × 768 (75 Hz)	1712
800 × 600 (85 Hz)	1048	1280 × 1024 (60 Hz)	1688

## Main Menu (continued)

### AUDIO

Sets speaker and headphones output.

Underlined values indicate factory defaults.

Sub menu	Settings	Description
<b>INPUT SELECT</b>	<u>AUTO</u> ANALOG	Selects speaker and headphones output. <AUTO> When an SDI input line is selected with the [INPUT SELECT] button on the front panel: embedded audio (SDI terminal) When input lines other than SDI1 or SDI2 are selected with the [INPUT SELECT] button on the front panel: analog (AUDIO input terminal) <ANALOG> Analog (AUDIO input terminal)
<b>EMBEDDED SELECT L</b>	CH1 - CH8 (Factory default: CH1)	Selects embedded audio channel output to the speaker (L) or headphones (L).
<b>EMBEDDED SELECT R</b>	CH1 - CH8 (Factory default: CH2)	Selects embedded audio channel output to the speaker (R) or headphones (R).
<b>LEVEL METER*1</b>	<u>OFF</u> ON	Selects embedded audio meter displayed by the on-screen display.
<b>CH SELECT</b>	<u>8CH</u> 4CH 2CH	Selects number of audio meter channels.
<b>0dB POINT</b>	OFF <u>ON</u>	Switches the 0 dB line displayed on the meter on and off.
<b>CH INFO.</b>	OFF <u>ON</u>	Switches the channel displayed on the meter on and off.

\*1 When ANALOG is selected in the "INPUT SELECT" menu, the LEVEL METER does not indicate the audio level even when set to ON.



## Main Menu (continued)

### DISPLAY SETUP

Underlined values indicate factory defaults.

Sub menu	Settings	Description
<b>WFM/ VECTOR</b>	<u>OFF</u> WFM VECTOR	Switches between “WFM/VECTOR” waveform and vector display. <WFM> Displays waveforms. <VECTOR> Displays vector waveforms.*3
<b>POSITION</b>	LB <u>RB</u> RT LT	Selects the position for the “WFM/VECTOR” waveform display.*3 <LB> Left Bottom <RB> Right Bottom <RT> Right Top <LT> Left Top
<b>VECTOR MODE</b>	× 8 × 4 × 2 <u>× 1</u>	Enlarges vector waveforms.*3 <× 8> 8× <× 4> 4× <× 2> 2× <× 1> 1×
<b>VECTOR SCALE</b>	<u>100%</u> 75%	Determines the scale of vector waveform. <100%> Displays it at 100% scale. <75%> Displays it at 75% scale.
<b>TIME CODE</b>	<u>OFF</u> ON	Turns the time code display on and off.*1
<b>MODE SELECT</b>	<u>LTC</u> VITC LUB VUB	Selects time code display mode.*1 <LTC> Displays linear time code (LTC). <VITC> Displays vertical interval time code (VITC). <LUB> Displays user bits included in LTC. <VUB> Displays user bits included in VITC.
<b>CLOSED CAPTION</b>	<u>OFF</u> ON	Turns closed caption display on and off.*2
<b>MODE SELECT</b>	CC4 CC3 CC2 <u>CC1</u>	Selects the cross caption display mode.*2

\*1 Available during HD-SDI input signals.

\*2 Available during VIDEO (NTSC) input. Closed captions appear as bright lines on line 21 when closed caption is set to ON and underscan is also on.

\*3 Opens the vector display during SDI signal input.

## Main Menu (continued)

### CONTROL

Underlined values indicate factory defaults.

Sub menu	Settings	Description
<b>CONTROL</b>	<u>LOCAL</u> REMOTE	Selects operation. (with control clock) <LOCAL> Enables front panel operation <REMOTE> Enables remote operation (front panel operation is locked) <sup>*1</sup>
<b>LOCAL ENABLE</b> <sup>*2</sup>	<u>DISABLE.</u> INPUT	Selects the disabled operation on the front panel when selecting "REMOTE" under "CONTROL". <DISABLE> Disables all front panel operations. <INPUT> All controls except [INPUT SELECT] and the volume knob are disabled.

\*1 The menu can be displayed when the lock is engaged.

Only "CONTROL/LOCAL ENABLE" menu items are available when the lock is engaged.

The picture adjusting knob is disabled when the lock is engaged.

The "LOCAL ENABLE" setting determines operations in lock mode. The volume knob (→ page 9, **5**) can be used during lock engagement.

The key mark is displayed during lock engagement.



\*2 Only available when "REMOTE" is selected under "CONTROL."

### HOURLMETER

Underlined values indicate factory defaults.

Sub menu	Settings	Description
<b>OPERATION</b>	<u>XXXXXXH</u> <sup>*3</sup>	Displays the number of hours it has been on.
<b>LCD</b>	<u>XXXXXXH</u> <sup>*3</sup>	Displays the number of hours that the backlight has been on.

\*3 "XXXXXX" indicates the number of hours.

"XXXXXX": 262800H (about 30 years), 262800 or greater number results in "OVER".

# Main Menu (continued)

■ List of setting restrictions (○: available, ×: not available)

CH	Input	VIDEO	SDI 1/2		YPbPr		RGB-VIDEO		RGB-COMP.	DVI-VIDEO		DVI-COMP.	
			SD	HD	SD	HD	SD	HD		SD	HD		
MARKER	MARKER	○	○	○	○	○	○	○	○	×	○	○	×
	16:9	○	○	○	○	○	○	○	○	×	○	○	×
	4:3	○	○	○	○	○	○	○	○	×	○	○	×
	BACK	○	○	○	○	○	○	○	○	×	○	○	×
	CENTER	○	○	○	○	○	○	○	○	×	○	○	×
	GPI PRESET1	○	○	○	○	○	○	○	○	×	○	○	×
	GPI PRESET2	○	○	○	○	○	○	○	○	×	○	○	×
	MARKER TYPE	○	○	○	○	○	○	○	○	×	○	○	×
CROSS HATCH	○	○	○	○	○	○	○	○	○	○	○	○	
VIDEO CONFIG	GAMMA SELECT	○	○	○	○	○	○	○	○	×	○	○	×
	FILM GAMMA	○	○	○	○	○	○	○	○	×	○	○	×
	COLOR TEMP.	○	○	○	○	○	○	○	○	○	○	○	○
	SHARPNESS MODE	○	○	○	○	○	○	○	○	×	○	○	×
	SHARPNESS H	○	○	○	○	○	○	○	○	×	○	○	×
	SHARPNESS V	○	○	○	○	○	○	○	○	×	○	○	×
	I-P MODE	○	○	○	○	○	○	○	○	×	×	○	×
	MONO	○	○	○	○	○	○	○	○	×	○	○	×
	ANAMO	○	○	○	○	○	○	○	○	×	○	○	×
	SD ASPECT	○	○	×	○	×	○	×	×	×	○	×	×
SCAN	○	○	○	○	○	○	○	○	×	○	○	×	
INPUT SELECT	VIDEO	○	×	×	×	×	×	×	×	×	×	×	×
	NTSC SETUP	○	×	×	×	×	×	×	×	×	×	×	×
	YPbPr/RGB	×	×	×	×	×	○	○	○	×	×	×	×
	COMPONENT LEVEL	×	×	×	×	×	○	×	×	×	×	×	×
	SELECT SYNC	×	×	×	○	○	○	○	×	×	×	×	×
	COMP.	×	×	×	×	×	×	×	○	×	×	×	×
DVI-D	×	×	×	×	×	×	×	×	×	○	○	○	
AUDIO	INPUT SELECT	○	○	○	○	○	○	○	○	○	○	○	○
	EMBEDED SELECT L	○	○	○	○	○	○	○	○	○	○	○	○
	EMBEDED SELECT R	○	○	○	○	○	○	○	○	○	○	○	○
	LEVEL METER	×	○	○	×	×	×	×	×	×	×	×	×
	CH SELECT	×	○	○	×	×	×	×	×	×	×	×	×
	0dB POINT	×	○	○	×	×	×	×	×	×	×	×	×
CH INFO.	×	○	○	×	×	×	×	×	×	×	×	×	
DISPLAY SETUP	WFM/VECTOR	○ <sup>*1</sup>	○	○ <sup>*2</sup>	○ <sup>*1</sup>	○ <sup>*1*2</sup>	×	×	×	×	×	×	×
	POSITION	○	○	○	○	○	×	×	×	×	×	×	×
	VECTOR MODE	×	○	○	×	×	×	×	×	×	×	×	×
	VECTOR SCALE	×	○	○	×	×	×	×	×	×	×	×	×
	TIME CODE	×	×	○	×	×	×	×	×	×	×	×	×
	MODE SELECT	×	×	○	×	×	×	×	×	×	×	×	×
	CLOSED CAPTION	○	×	×	×	×	×	×	×	×	×	×	×
MODE SELECT	○	×	×	×	×	×	×	×	×	×	×	×	
Picture adjustment knob	PHASE	○	○	○	○	○	○	○	○	×	○	○	×
	CHROMA	○	○	○	○	○	○	○	○	×	○	○	×
	BRIGHT	○	○	○	○	○	○	○	○	○	○	○	○
	CONTRAST	○	○	○	○	○	○	○	○	○	○	○	○
	BACKLIGHT	○	○	○	○	○	○	○	○	○	○	○	○

\*1 The VECTOR display appears only during SDI input.

\*2 It does not appear during 1080/23P, 24P, 25P, 29P and 30P input.

# REMOTE Specifications

This monitor permits remote operation via GPI/RS-232C terminal.

## GPI terminal

GPI screen items correspond to the following terminals. Use the GPI menu to assign functions to each terminal (→ page 29). Functions assigned to terminals are executed when GND (pin 5) is short-circuited (ON) or open (OFF).

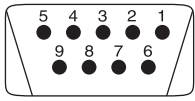

GPI Terminal (9P)

Pin number	Signal
1	GPI1
2	GPI2
3	GPI3
4	GPI4
5	GND
6	GPI5
7	GPI6
8	GPI7
9	GPI8

### ■ Operating conditions

Level operation: Operates when GND is short-circuited.  
Edge operation: Operates when GND changes from open to short-circuited.

\* When level operation is assigned to more than one terminal, the function operates as long as one of the terminals is short-circuited.

Assigned item	Function	Operating conditions
UNDEF	Undefined (no function assigned)	—
MARKER1 ON/OFF* <sup>1</sup>	Switches marker display defined in “GPI PRESET1” (→ page 18) in the “MARKER” menu.	Level operation (Short-circuited: ON, Open: OFF)
MARKER2 ON/OFF* <sup>1</sup>	Switches marker display defined in “GPI PRESET2” (→ page 18) in the “MARKER” menu.	Level operation (Short-circuited: ON, Open: OFF)
MARKER BACK HALF* <sup>2</sup>	Reduces the brightness of the background outside the marker displayed in “GPI PRESET1” (→ page 18) to 50%.	Level operation (Short-circuited: ON, Open: OFF)
MARKER BACK BLACK* <sup>2</sup>	Reduces the brightness of the background outside the marker displayed in “GPI PRESET1” (→ page 18) to 0%.	Level operation (Short-circuited: ON, Open: OFF)
CENTER MARKER	Turns the center marker display on and off. (When other markers are displayed, this marker is superimposed on other markers.)	Level operation (Short-circuited: ON, Open: OFF)
INPUT SEL. VIDEO	Switches the input line to VIDEO.	Edge/level operation
INPUT SEL. SDI1	Switches the input line to SDI1.	Edge/level operation
INPUT SEL. SDI2	Switches the input line to SDI 2.	Edge/level operation
INPUT SEL. YP <sub>B</sub> P <sub>R</sub> /RGB	Switches the input line to YP <sub>B</sub> P <sub>R</sub> /RGB.	Edge/level operation
INPUT SEL. DVI-D	Switches the input line to DVI-D.	Edge/level operation
SD ASPECT	Sets the aspect ratio for SD signal input. (Disabled during HD and PC signal input)	Level operation (Short-circuited: 16:9, open: 4:3)
SCAN	Switches the scan mode between “UNDER” and “NORMAL”. (Disabled during PC signal input)	Level operation (Short-circuited: UNDER, Open: NORMAL)
R-TALLY* <sup>3</sup>	Lights the red tally.	Level operation (Short-circuited: ON, Open: OFF)
G-TALLY* <sup>3</sup>	Lights the green tally.	Level operation (Short-circuited: ON, Open: OFF)
MONO	Switches between color and monochrome (MONO). (Disabled during PC signal input)	Level operation (Short-circuited: monochrome, Open: color)
GAMMA SEL. FILM	Switches the gamma curve to FILM mode.	Level operation (Short-circuited: FILM mode, Open: STANDARD mode)
GAMMA SEL. STUDIO/PST	Switches the gamma curve to STUDIO/PST mode.	Level operation (Short-circuited: STUDIO/PST mode, Open: STANDARD mode)
SELECT SYNC* <sup>4</sup>	Selects the SYNC when using YP <sub>B</sub> P <sub>R</sub> /RGB-VIDEO input.	Level operation (Short-circuited: EXT, Open: INT)
PIXEL TO PIXEL	Switches screen display between input size and display size.	Level operation (Short-circuited: ON, Open: OFF)

\*1 When a 16:9 marker and a 4:3 marker are simultaneously selected and activated on a 16:9 aspect ratio display, both markers are displayed.

\*2 When a 16:9 marker and a 4:3 marker are simultaneously displayed, the background of the marker selected by the 16:9 marker is controlled.

\*3 When “R-TALLY” and “G-TALLY” simultaneously go on, the tally color changes to orange.

\*4 This is only enabled when “RGB-VIDEO” is selected under “YP<sub>B</sub>P<sub>R</sub>/RGB” in the “INPUT SELECT” menu.

# REMOTE Specifications (continued)

## Priority of assigned functions

- When both “MARKER1” and “MARKER2” are activated at the same time, “MARKER1” has priority. However, when the display aspect ratio is 4:3, the “MARKER1” aspect ratio is 16:9 and the “MARKER2” aspect ratio is 4:3, “MARKER2” is displayed. In this case, the “MARKER2” background is controlled.
- When “MARKER BACK HALF” and “MARKER BACK BLACK” are activated at the same time, “MARKER BACK BLACK” has priority.
- During GPI edge operation and two or more of “INPUT SEL. VIDEO”, “INPUT SEL. SDI1”, “INPUT SEL. SDI2”, “INPUT SEL. YPbPr/RGB” and “INPUT SEL. DVI-D” are simultaneously activated, priority goes to the last activated item. During level operation, priority is assigned in the following order: “INPUT SEL. VIDEO”, “INPUT SEL. SDI1”, “INPUT SEL. SDI2”, “INPUT SEL. YPbPr/RGB” and “INPUT SEL. DVI-D”.
- When “GAMMA SEL. FILM” and “GAMMA SEL. STUDIO/PST” are activated at the same time, “GAMMA SEL. FILM” has priority.

## RS-232C terminal

The following diagram and the table on the lower right show RS-232C terminal pin arrangement and connections. For details on systems using RS-232C, be sure to consult your dealer.

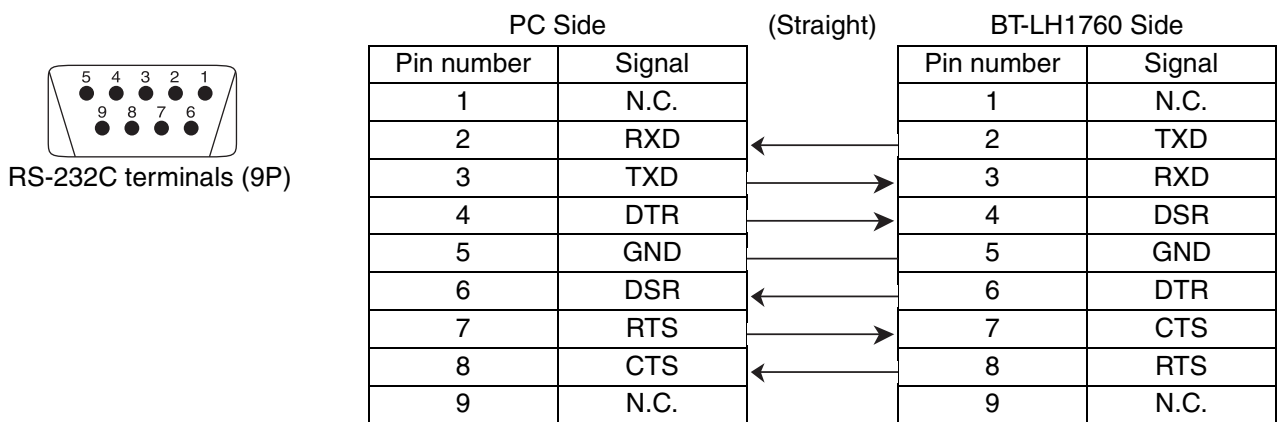

## RS-232C remote control method

### Connectors and signals

Connector: D-SUB 9-pin (female)

Signal

Pin number	Signal	Description
1	N.C.	Not connected
2	TXD	Transmission data
3	RXD	Reception data
4	DSR	Connected inside
5	GND	Ground
6	DTR	Connected inside
7	CTS	Connected inside
8	RTS	Connected inside
9	N.C.	Not connected

### Communication parameters

Signal level	RS-232C compliant
Synchro system	Asynchronous
Transfer rate	9600 bps
Parity	None
Data length	8 bit
Stop bit	1 bit
Flow control	None

### Command format

STX (02h)	Command	:	Data	ETX (03h)
-----------	---------	---	------	-----------

- The command is the 3-character string starting with STX and ending with ETX.
- Append any data after the colon (:) following the command, as required.

### Response formats

#### 1. Setting command response

STX (02h)	Command	ETX (03h)
-----------	---------	-----------

#### 2. Query command response

STX (02h)	Data	ETX (03h)
-----------	------	-----------

#### 3. Error response

STX (02h)	Error code	ETX (03h)
-----------	------------	-----------

Error codes

ER001: Invalid command

ER002: Parameter error

## REMOTE Specifications (continued)

### ■ Setting command

No	Command	Description	Data	Response
1	IIS	Input switch	0: SDI1            1: SDI2            2: VIDEO 3: YP <sub>B</sub> P <sub>R</sub> /RGB    6: DVI-D	IIS
2	VPC	Image quality adjustment	CON00-60 : Contrast settings BRI00-60 : Brightness settings CRO00-60 : Chroma settings PHA00-60 : Phase settings	VPC
3	OBO	Blue only	0: OFF                            1: ON	OBO
4	OHV	HV Delay	0: OFF            1: H DELAY            2: V DELAY 3: HV DELAY	OHV
5	VBL	Backlight	00-60: Backlight setting	VBL
6	DCH	Cross hatch	0: OFF            1: LOW            2: HIGH	DCH
7	DSD	Status display	0: CONTINUE    1: 3SEC OFF    2: OFF	DSD
8	ISM	Analog mode	ANA0: YP <sub>B</sub> P <sub>R</sub> ANA1: RGB-VIDEO ANA2: RGB-COMP.	ISM
9	IRF	SELECT Sync	0: INT                            1: EXT	IRF
10	ISM	DVI-D mode	DVI0: DVI-VIDEO    DVI1: DVI-COMP.	ISM
11	DMK	Marker settings	16:9 marker MK100: OFF            MK101: 80% MK102: 88%            MK103: 93% MK104: 95%            MK105: 14:9 MK106: 13:9            MK107: 4:3 MK108: 90%            MK109: CNSCO MK110: VISTA 4:3 marker MK200: OFF            MK201: 80% MK202: 88%            MK203: 93% MK204: 95%            MK208: 90% Marker background BAK0: NORMAL    BAK1: HALF    BAK2: BLACK Center marker CMK0: OFF            CMK1: ON	DMK
12	MGM	Gamma selection	1: STANDARD    2: FILM            3: STUDIO/PST	MGM
13	MCT	Color temperature settings	00: D56            01: D65            02: D93 03: VAR1            04: VAR2            05: VAR3 10-73: USER0 - 63	MCT
14	VPC	Sharpness settings	SHP0: LOW            SHP1: HIGH SHH00-30 Horizontal sharpness settings SHV00-30 Vertical sharpness settings	VPC
15	MIP	IP mode settings	0: MODE1                            1: MODE2	MIP
16	OMO	Monochrome settings	1: OFF                            2: ON	OMO
17	MAS	SD aspect settings	0: 16:9                            1: 4:3	MAS
18	MSC	Scan settings	0: NORMAL                            1: UNDER	MSC
19	MCO	Remote settings	0: LOCAL                            1: REMOTE	MCO
20	MLE	Remote operation settings	0: DISABLE                            1: INPUT	MLE

# REMOTE Specifications (continued)

## ■ Query command

No	Command	Description	Data	Response
1	QIS	Input selection		0: SDI1 3: RGB-VIDEO 9: DVI-VIDEO 1: SDI2 4: VIDEO 10: DVI-COMP. 2: YPbPr 6: RGB-COMP.
2	QPC	Image quality adjustment	CON : Contrast setting value	00-60
			BRI : Brightness setting value	00-60
			CRO : Chroma setting value	00-60
			PHA : Phase setting value	00-60
3	QBO	Blue only		0: OFF 1: ON
4	QBL	Backlight		00-60
5	QCH	Cross hatch		0: OFF 1: LOW 2: HIGH
6	QMK	Marker	MAK : Area marker*1	00: OFF 03: 93% 06: 13:9 09: CNSCO 01: 80% 04: 95% 07: 4:3 10: VISTA 02: 88% 05: 14:9 08: 90%
			BAK : Background	0: NORMAL 1: HALF 2: BLACK
			CMK : Center marker	0: OFF 1: ON
7	QGM	Gamma		1: STANDARD 2: FILM 3: STDIO/PST
8	QCT	Color temperature		00: D56 03: VAR1 10-73: USER0 - 63 01: D65 04: VAR2 02: D93 05: VAR3
9	QPC	Sharpness	SHP : Sharpness mode	0: LOW 1: HIGH
			SHH : Horizontal sharpness value	00-30
			SHV : Vertical sharpness value	00-30
10	QIP	IP mode		0: MODE1 1: MODE2
11	QMO	Monochrome		1: OFF 2: ON
12	QAS	Aspect		0: 16:9 1: 4:3
13	QSC	Scan		0: NORMAL 1: UNDER
14	QAN	Analog mode		0: YPbPr 1: RGB-VIDEO 2: RGB-COMP.
15	QSY	SELECT sync		0: INT 1: EXT
16	QDV	DVI-D mode		0: DVI-VIDEO 1: DVI-COMP.
17	QFR	Format		00: NO SIGNAL 01: 1080/60I 03: 1080/50I 05: 1080/29P 07: 1080/24P 09: 1080/24PsF 13: 720/60P 15: 576/50I 17: 480/60I 20: 1080/60P 22: 1080/50P 50: 640 × 400 (70 Hz) 51: 640 × 480 (60 Hz) 52: 640 × 480 (75 Hz) 53: 640 × 480 (85 Hz) 54: 800 × 600 (60 Hz) 55: 800 × 600 (75 Hz) 56: 800 × 600 (85 Hz) 57: 1024 × 768 (60 Hz) 58: 1024 × 768 (70 Hz) 59: 1024 × 768 (75 Hz) 60: 1024 × 768 (85 Hz) 61: 1280 × 768 (60 Hz) 62: 1280 × 768 (75 Hz) 63: 1280 × 1024 (60 Hz) 64: 800 × 600 (70 Hz) 65: 1280 × 768 (50 Hz) FF: UNSUPPORT SIGNAL 02: 1080/59I 04: 1080/30P 06: 1080/25P 08: 1080/23P 10: 1080/23PsF 14: 720/59P 16: 480/60P 18: 576/50P 21: 1080/59P 23: 720/50P
18	QID	Model		BT-LH1760

\*1 When both 16:9 and 4:3 markers are displayed, the 16:9 marker state is returned.

# How to Attach the Rack Mount

---

The monitor can be fitted with an optional BT-MA1710G rack mount adaptor to enable mounting it in a standard 19-inch rack (7U size height). The steps below show how to attach it.

**1. Remove the three screws on the back and base of the monitor and remove the stand.**

**2. Use the supplied screws to attach the rack mount adaptors to both sides of the monitor.**

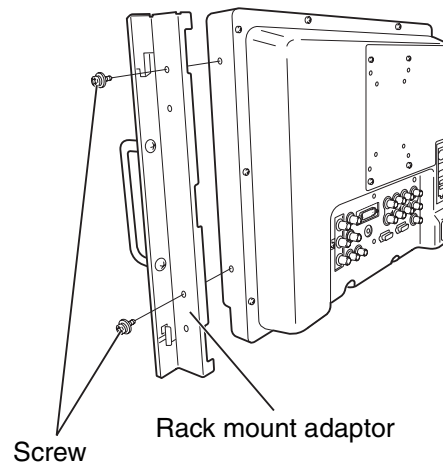
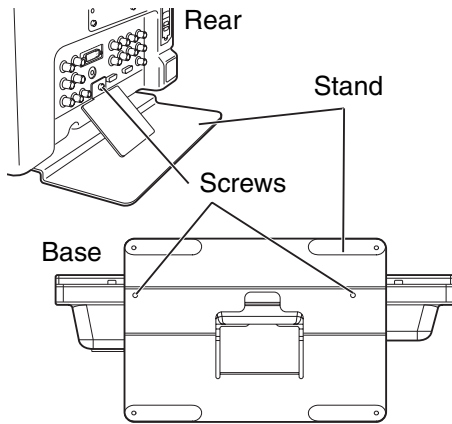

## Maintenance Inspections

---

Maintenance inspections through periodic and appropriate maintenance are essential to keep the monitor in optimum condition and ensure safe operation. Be sure to conduct the following maintenance inspections to enable long-term, full use of all its functions.

### **Necessity of periodic maintenance service**

The backlight in the LCD panel is a consumable component that deteriorates over time leading to gradual loss of performance that could eventually result in a malfunction.

Conventional after-sales service that replaces parts when they break down should therefore be combined with a regularly conducted comprehensive service to maintain normal operation and prevent unforeseen breakdown of consumables.



# Error and Warning Displays

---

If for any reason an error occurs in this monitor, the LEDs above the picture adjusting knob flash at **1-second intervals** to inform of the error/warning.

Error and Warning displays	Symptom	Remedy
<b>Inverter error</b>	If a malfunction occurs in the inverter that controls backlight brightness, the backlight goes off and the screen turns black.	Turn off the power and then turn it back on. If the problem still persists, consult your dealer.
<b>Warning of drop in external DC input voltage/low voltage</b>	A "LOW VOLTAGE" indication in blue flashes on the screen. This means that the external DC power supply input voltage has dropped to approximately 11.3 V or less.	<ul style="list-style-type: none"> <li>• If you use a battery pack as an external DC power supply, replace it with a fully charged battery pack.</li> <li>• Connect an external DC power supply providing 11.0 V or more. Set the POWER switch to the off position and then set it to the on position again.</li> </ul>
	The "LOW VOLTAGE" indication flashes in red on the screen and the power is turned off approximately 4 seconds later. This means that the external DC power supply input voltage has dropped below 11.0 V.	

## Maintenance

---

- Clean the cabinet and protection panel by gently wiping it with a soft cloth.  
To remove stubborn soiling, use a cloth dampened in a weak neutral detergent solution and thoroughly wrung out. Then wipe with a dry cloth. Any moisture entering the monitor could damage it.
- Do not use benzene, thinner and similar solvents for cleaning.  
They could discolor the surface and cause the paint to peel.
- Do not directly expose the monitor to spray cleaning.  
Any moisture entering the monitor could damage it.

# Specifications

## ■ General

### Input power

Power supply:	Power consumption:
AC: 100 V - 240 V, 50/60 Hz	0.6 A - 0.3 A
DC: 12 V (11 V - 17 V)	4.0 A

 is the safety information.

### Dimensions:

- Including stand  
430 (W) mm × 323.5 (H) mm × 198 (D) mm  
[16 <sup>15</sup>/<sub>16</sub> (W) inches × 12 <sup>3</sup>/<sub>4</sub> (H) inches × 7 <sup>13</sup>/<sub>16</sub> (D) inches]
- Main body only, not including stand  
430 (W) mm × 309 (H) mm × 81.1 (D) mm  
[16 <sup>15</sup>/<sub>16</sub> (W) inches × 12 <sup>3</sup>/<sub>16</sub> (H) inches × 3 <sup>3</sup>/<sub>16</sub> (D) inches]

### Mass:

- Including stand  
7.1 kg (15.7 lb)
- Main body only, not including stand  
6.2 kg (13.7 lb)

### Operating temperature:

+5 °C to +35 °C (+41 °F to +95 °F)

### Operating humidity:

20 % to 80 % (no condensation)

### Storage temperature:

-20 °C to +60 °C (-4 °F to +140 °F)

## ■ Panel

Size: 17.0 type  
Aspect ratio: 15:9  
Number of pixels: 1280 × 768 (WXGA)  
Display colors: Approx. 16,770,000 colors  
View angle: 176° up/down, 176° right/left

## ■ Input/output Connectors

### Image signal input:

#### VIDEO:

1 line, BNC × 2  
(1 connector with through-out configuration)

#### Analog component:

1 line for YPbPr/RGBS, BNC × 8  
(4 connectors with through-out configuration)  
However, when input is RGB-COMP. this becomes  
BNC × 5 (R, G, B, HD, and VD).  
(Through-out is not available)

#### SDI:

Compliant with SMPTE 274M, 296M, 259M-C and  
ITU-R BT.656-4  
2 lines, BNC × 3  
(1 connector with switched-out configuration)

#### DVI-D (HDCP compatible): TMDS single link

1 line, DVI-D × 1  
Vertical frequency: 50.0 - 60.0 Hz  
Horizontal frequency: 31.5 - 67.5 kHz  
Dot clock: 25 - 165 MHz

Audio input: Pin jack × 2 (stereo)  
Headphone output: Stereo minijack M3 × 1  
GPI: D-SUB, 9 pins × 1  
RS-232C: D-SUB, 9 pins × 1  
DC input: XLR, 4 pins × 1

## ■ Signal level

### VIDEO

EXT SYNC signal level: 0.3 Vp-p to 4.0 Vp-p  
HD/VD signal level: TTL level

### AUDIO

AUDIO input level: 0.5 Vrms  
Speaker output: 0.5 W + 0.5 W  
Headphone output: 32 Ω, level adjustable

## ■ SDI embedded audio

### HD-SDI: SMPTE299M compatible

Sampling rate: 48 kHz, synchronous/asynchronous  
8 ch

### SD-SDI: SMPTE272M compatible

Sampling rate: 48 kHz, synchronous  
4 ch

## ■ Standard accessories

<For BT-LH1760P>

Operationg instructions × 1  
Warranty (Card) × 1  
Power cord × 1  
Power cord hook × 1  
Screw × 1  
<For BT-LH1760E>  
Operationg instructions × 1  
AC mains lead × 2  
AC mains lead hook × 1  
Screw × 1

## ■ Optional units

Rack Mount Adaptor  
BT-MA1710G  
Wall Mount Adaptor  
BT-WMA17G  
Protection Panel  
BT-PRP17G

Inrush current, measured according to European standard  
EN55103-1: 5.62A

## Specifications (continued)

■ List of compatible signal formats (○: Compatible, △: Limited compatibility)

Input signal formats	VIDEO	SDI1	SDI2	YPbPr	RGB-VIDEO	RGB-COMP.	DVI VIDEO	DVI COMP.
NTSC	○							
PAL	○							
480/59.94I		○	○	○	○			
480/59.94P				○	○		○	
576/50I		○	○	○	○			
576/50P				○	○		○	
720/50P		○	○	○			○	
720/59.94P		○	○	○	○		○	
720/60P		○	○	○	○		○	
1035/59.94I		△ <sup>*1</sup>	△ <sup>*1</sup>	△ <sup>*1</sup>	△ <sup>*1</sup>			
1035/60I		△ <sup>*2</sup>	△ <sup>*2</sup>	△ <sup>*2</sup>	△ <sup>*2</sup>			
1080/23.98PsF		○	○	○				
1080/24PsF		○	○	○				
1080/23.98P		○	○	○				
1080/24P		○	○	○				
1080/25P		○	○	○				
1080/29.97P		○	○	○				
1080/30P		○	○	○				
1080/50I		○	○	○	○		○	
1080/50P				○			○	
1080/59.94I		○	○	○	○		○	
1080/60I		○	○	○	○		○	
1080/59.94P				○			○	
1080/60P				○			○	
640 × 400 (70 Hz)						○		
640 × 480 (60 Hz)						○		○
640 × 480 (75 Hz)						○		
640 × 480 (85 Hz)						○		
800 × 600 (60 Hz)						○		○
800 × 600 (70 Hz)						○		
800 × 600 (75 Hz)						○		
800 × 600 (85 Hz)						○		
1024 × 768 (60 Hz)						○		○
1024 × 768 (70 Hz)						○		
1024 × 768 (75 Hz)						○		
1024 × 768 (85 Hz)						○		
1280 × 768 (50 Hz)						○		○
1280 × 768 (60 Hz)						○		○
1280 × 768 (75 Hz)						○		
1280 × 1024 (60 Hz)						○		○

\*1 When 1035/59.94I signal is input, displayed as 1080/59.94I. Other various marker displays will use the 1080/59.94I marker.

\*2 When 1035/60I signal is input, displayed as 1080/60I. Other various marker displays will use the 1080/60I marker.

Weight and dimensions when shown are approximately.  
Specifications are subject to change without notice.

## Information on Disposal for Users of Waste Electrical & Electronic Equipment (private households)

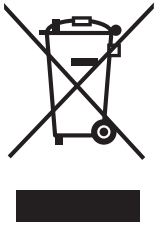

This symbol on the products and/or accompanying documents means that used electrical and electronic products should not be mixed with general household waste.

For proper treatment, recovery and recycling, please take these products to designated collection points, where they will be accepted on a free of charge basis. Alternatively, in some countries you may be able to return your products to your local retailer upon the purchase of an equivalent new product.

Disposing of this product correctly will help to save valuable resources and prevent any potential negative effects on human health and the environment which could otherwise arise from inappropriate waste handling. Please contact your local authority for further details of your nearest designated collection point.

Penalties may be applicable for incorrect disposal of this waste, in accordance with national legislation.

### For business users in the European Union

If you wish to discard electrical and electronic equipment, please contact your dealer or supplier for further information.

### Information on Disposal in other Countries outside the European Union

This symbol is only valid in the European Union.

If you wish to discard this product, please contact your local authorities or dealer and ask for the correct method of disposal.

# Panasonic<sup>®</sup>

## Panasonic Broadcast & Television Systems Company Unit Company of Panasonic Corporation of North America

### Executive Office:

One Panasonic Way 4E-7, Secaucus, NJ 07094 (201) 348-7000

### EASTERN ZONE:

One Panasonic Way 4E-7, Secaucus, NJ 07094 (201) 348-7196

**Southeast Region:** (201) 348-7162

### WESTERN ZONE:

3330 Cahuenga Blvd W., Los Angeles, CA 90068 (323) 436-3500

### Government Marketing Department:

One Panasonic Way 2E-10, Secaucus, NJ 07094 (201) 348-7587

### Broadcast PARTS INFORMATION & ORDERING:

9:00 a.m. – 5:00 p.m. (EST) (800) 334-4881/24 Hr. Fax (800) 334-4880

Emergency after hour parts orders (800) 334-4881

### TECHNICAL SUPPORT:

Emergency 24 Hour Service (800) 222-0741

### Panasonic Canada Inc.

5770 Ambler Drive, Mississauga, Ontario L4W 2T3 (905) 624-5010

### Panasonic de Mexico S.A. de C.V.

Av angel Urraza Num. 1209 Col. de Valle 03100 Mexico, D.F. (52) 1 951 2127

### Panasonic Puerto Rico Inc.

San Gabriel Industrial Park, 65th Infantry Ave., Km. 9.5, Carolina, Puerto Rico 00630 (787) 750-4300

---

### Professional & Broadcast IT Systems Business Unit Europe

### Panasonic AVC Systems Europe a Division of Panasonic Marketing Europe GmbH

Hagenauer Str. 43, 65203 Wiesbaden-Biebrich Deutschland Tel: 49-611-235-481

---